

Aqlus

In luce, con stile

Aqlus è il brand di Biffi Luce dedicato all'illuminazione di spazi architettonici e di arredo. Collaboriamo costantemente con designer affermati per ideare sistemi di illuminazione che, coniugando design contemporaneo e ricerca tecnica, enfatizzano e risaltano le caratteristiche progettuali ed emozionali della luce.

La bellezza della forma, la funzionalità del prodotto, la mutevolezza, fluidità e cangianza della vera protagonista degli spazi, la luce. Tutto questo è Aqlus.

Aqlus is a brand of Biffi Luce dedicated to the enlightenment of architectural spaces. We constantly collaborate with prominent designers to realize innovative and technologically advanced lighting systems which emphasize and enhance the planning and emotional characteristics of light. Beautiful design, product functionality, mutability, fluidity and adjustability of the real protagonist of space, light. This is Aqlus.



E L E G A N T E
c a n g i a n t e
F L U I D A
m u t e v o l e

LUCE

E M O Z I O N E

P R O G E T T O

D E S I G N

Aqplus

INFORMAZIONI UTILI

USEFUL INFORMATION

SIMBOLI / SYMBOLS

	Fascio <i>Beam</i>
TC	Temperatura colore <i>Colour temperature</i>
IP	Grado di protezione (corpi solidi e liquidi) <i>Protection degree (solid and liquid objects)</i>
CRI	Resa cromatica <i>Colour rendering index</i>
EEl	Classe energetica <i>Energy class</i>
RG	Sicurezza fotobiologica <i>Photobiological safety</i>
03	Colore / finitura (vedi pag. 297) <i>Colour / finishing (see p. 297)</i>
08	
A	Accessori <i>Accessories</i>
D	Driver <i>Driver</i>
IK	Grado di protezione (impatti meccanici esterni) <i>Protection degree (external mechanical impacts)</i>

COME COMPORRE IL CODICE PRODOTTO

Per comporre il codice è necessario osservare la tabella riportante i dati tecnici del prodotto.
/DIMM 2-3 indica che è possibile richiedere la versione dimmerabile (informazioni tecniche a pag. 304/305).
/EM indica che è possibile richiedere la versione emergenza (informazioni tecniche a pag. 306).

HOW TO COMPOSE THE PRODUCT CODE

The product code can be composed observing the table reporting the technical specifications of the fixture.
/DIMM 2-3 means it is possible to request a dimmable version of the lamp (technical specification p. 304/305).
/EM means it is possible to request an emergency version of the lamp (technical specification p. 306).

ESEMPIO / EXAMPLE cod. A8-660PL.140.30/DIMM2.46T008

CODICE	W	Lm (3000K)
A8-660PL.112...	35	4400
A8-660PL.140...	44	5500

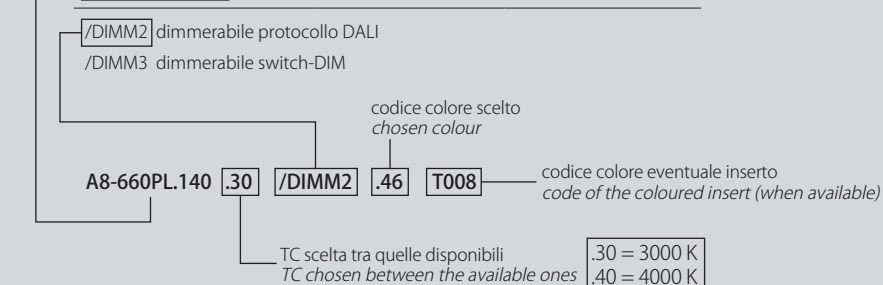

Il flusso nominale è riferito ai valori dichiarati dalla casa costruttrice ad una temperatura di giunzione di 65°C.
Tutti i flussi nominali inseriti a catalogo si riferiscono ad una TC di 3000K.

The reported luminous flux is the one declared by the light manufacturer and it refers to the flux emitted by the LED light at a junction temperature of 65°C.
All the luminous fluxes included in the catalogue refer to a colour temperature of 3000K.



La marcatura CE significa libertà di circolazione nel mercato europeo, è quindi il passaporto obbligatorio per le frontiere dell'Unione Europea.
Tutti i nostri prodotti sono dichiarati e certificati rispondenti alle direttive specifiche quali: 2006/95 CE e 93/68 CEE relative alla sicurezza nonché alle direttive 2004/108/CE relativa alla compatibilità elettromagnetica.

The CE mark means that the products are allowed free circulation within the European market and it is therefore a compulsory requirement to allow products to cross the European frontiers. All our products carry approval declarations which conforms to the following specific directives: 2006/95 CE and 93/68 CEE concerning electrical safety as well as 2004/108/CE concerning electromagnetic compatibility.

PARETE/PLAFONE

WALL/CEILING 9

MISSY
ALI
MIA
GAIA
LYNN
MAYA
BEA
EMMA
EMMA UP
LISA
IRILED
EK CUBO
MUR
FUSION
SHARP
WHEEL

SOSPENSIONI

HANGINGS 55

MISSY
MERY
FROY
SHARP
TIMBER
FUSION

PROIETTORI/BINARI

SPOTLIGHTS/TRACKS 81

MIKE
MIKE GRANDE
TOV
MUR
ARCO
ZETA
HARRY
DUE (BINARI / TRACKS)

INCASSI

RECESSED 119

BEN
PALACE
ROY
JACK
GIO'
FLO
BISS
IRO
IROTO
EDO
CHIC
MIKE
MIKE GRANDE
EK
IDRO
COMFORT
DEDILUS
ZJ
VELO
AMBO

SISTEMI

SYSTEMS 173

TIMBER
FUSION SOSPENSIONE
FUSION PLAFONE
FUSION INCASSO
LINE SOSPENSIONE
LINE PLAFONE
LINE INCASSO
MINILINE
AT
ESPO'
ESPO'2
FROY
ASY
LATY

ESTERNI

OUTDOOR 279

CABANA
HAIKU
OYS
PLEUS
JAGO

DATI TECNICI

TECHNICAL DATA 297

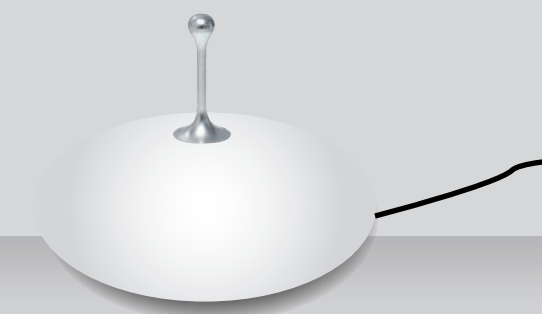

PARETE/PLAFONE
WALL/CEILING

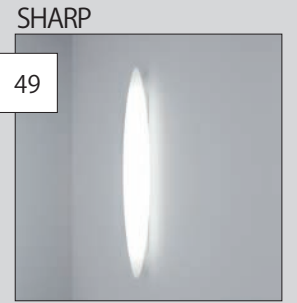
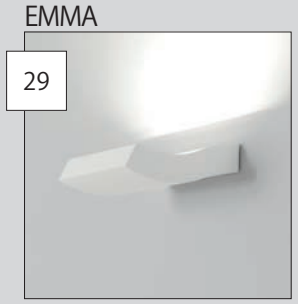
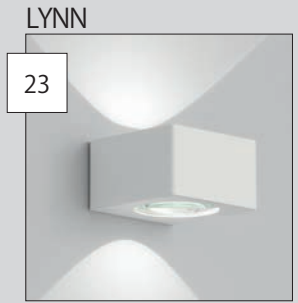
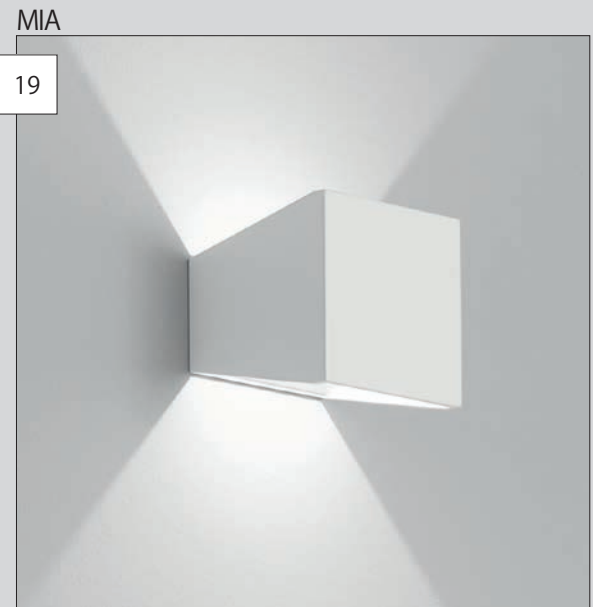
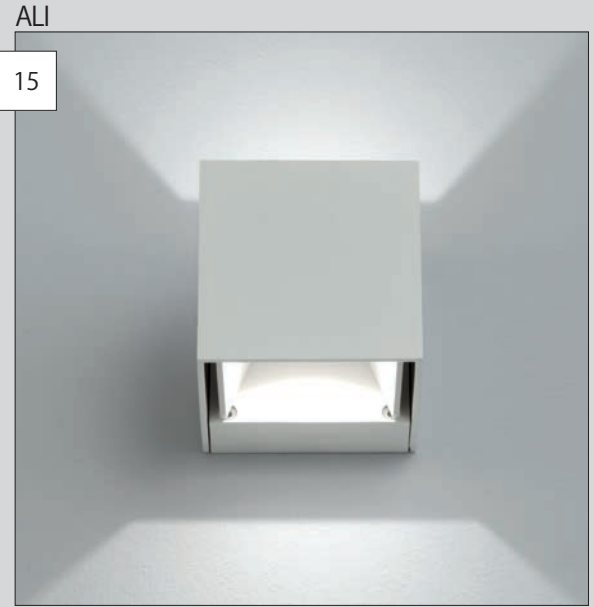



MISSY

PLAFONE / CEILING

Apparecchio a plafone dalla caratteristica forma conica, Missy è realizzato in alluminio tornito verniciato a polvere epossipoliestere. Equipaggiato con sorgente LED ad alta efficienza a tecnologia Chip On Board, è disponibile in due misure, piccola e grande, e in cinque versioni, da 13W, 12W, 17W, 25W e 33W. I modelli da 13W e 25W non necessitano di driver e, essendo privi di parabola, emettono una luce diffusa. Le versioni da 12W, 17W e 33W, invece, sono dotate di parabola metallizzata da 50° e di driver. A richiesta vengono fornite parabole da 16° per Missy Piccolo e da 20° per Missy Grande. Il grado di protezione contro la penetrazione di polvere, corpi solidi e liquidi è IP40.

Ceiling lamp identified by a conic shape, Missy is made from epoxy polyester powder coated aluminium. Complete with a Chip On Board technology high efficiency LED light source, it is available in small and large size and in five versions. No driver is needed for the 13W and the 25W models, which do not have a reflector, while the 12W, 17W and 33W versions are furnished with a 50° reflector and driver. 16° and 20° reflectors available on request. Its degree of protection against the penetration of dust, solid objects and liquids is IP40.

MISSY PICCOLO

CODICE	W	Lm (3000K)	
A4-640.13...	13	1100	110°
A4-641.15...	12	1880	50° <small>(a richiesta 16°) (16° on request)</small>
A4-641.20...	17	2620	50° <small>(a richiesta 16°) (16° on request)</small>

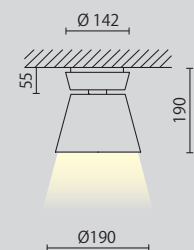

MISSY GRANDE

CODICE	W	Lm (3000K)	
A4-645.25...	25	2000	110°
A4-646.35...	33	4400	50° <small>(a richiesta 20°) (20° on request)</small>

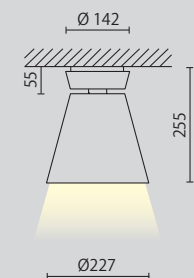

	(vedi tabella) / (see table)
TC	3000K / 4000K
IP	40
CRI	>80
EEL	A+ (13W-25W) A++ (12W-17W-33W)
RG	1
03	Nero lucido
08	Bianco satinato



ALI

PARETE / WALL







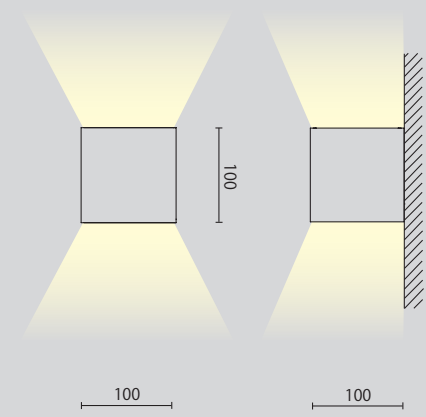

La rigidità del cubo e la poliedricità della luce, il cui fascio è regolabile grazie a due alette inserite all'interno del volume. Ali è un apparecchio da parete biemissione realizzato in alluminio verniciato a polvere epossipoliestere. Viene fornito con due sorgenti LED ad alta efficienza con tecnologia Chip On Board e driver. Il grado di protezione contro la penetrazione di polvere, corpi solidi e liquidi è IP54.

The starkness of a cube and the versatility of light, whose beam is adjustable thanks to two little wings hidden in the volume. Ali is a double emission wall lamp made from epoxy polyester powder coated aluminium and it is equipped with two Chip On Board technology high efficiency LED light sources and driver. Its degree of protection against the penetration of dust, solid objects and liquids is IP54.



CODICE	W	Lm (3000K)
A9-660.30	10	2x420



-  Max 90°
-  TC 3000K
4000K (a richiesta / on request)
-  IP 54
-  CRI >80
-  EEI A+
-  RG 1
-  08 Bianco satinato
-  38 Grigio antracite



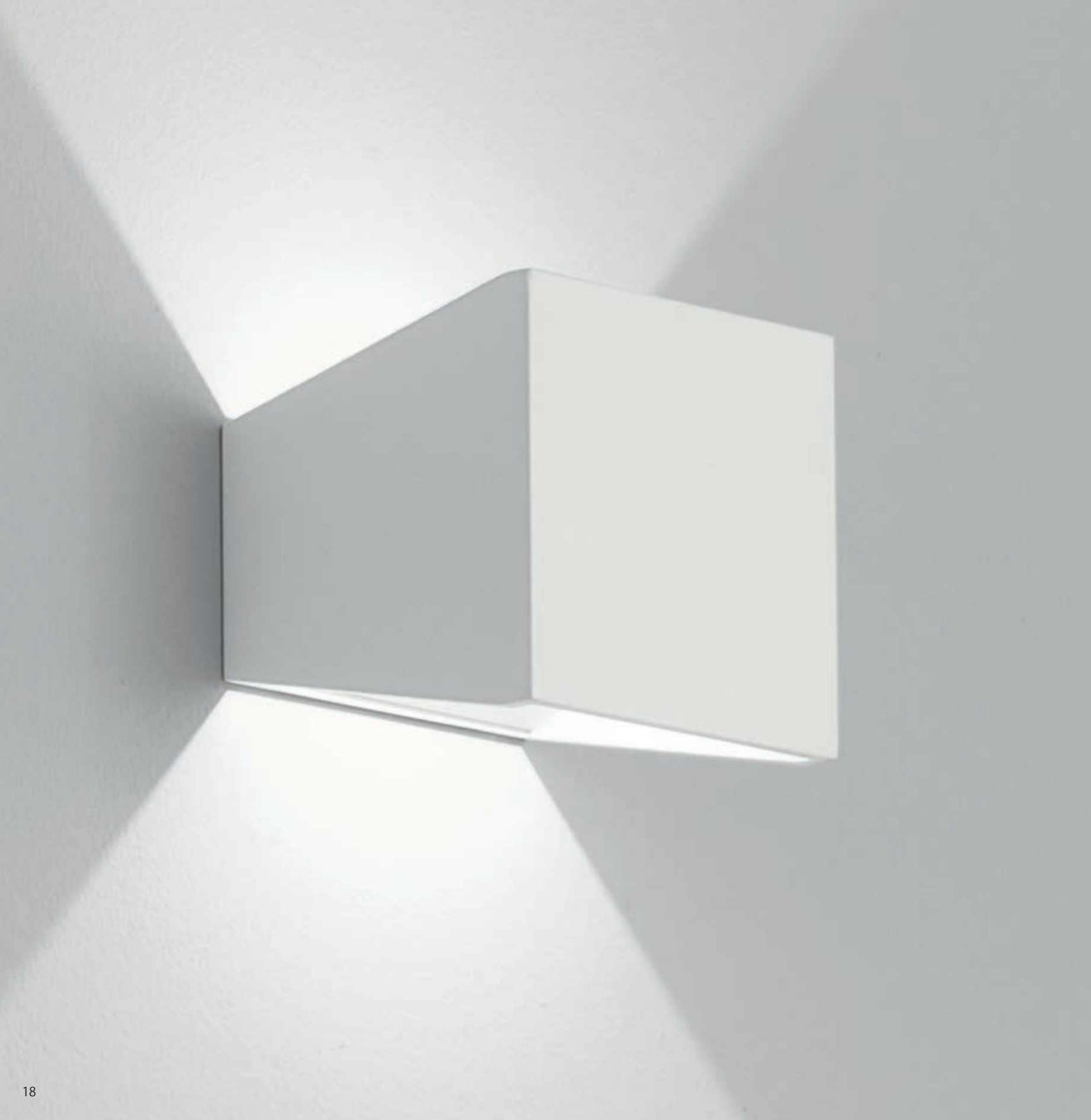



MIA

PARETE / WALL

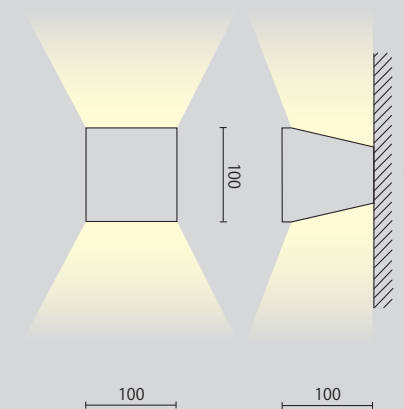
CODICE	W	Lm
A9-651.30	11	885



	70°
TC	3000K
IP	20
CRI	>80
EEL	A+
RG	0
08	Bianco satinato

Un gioco di tagli simmetrici caratterizza Mia, apparecchio da parete biemissione realizzato in alluminio verniciato a polvere epossipoliestere stabilizzata ai raggi UV. Viene fornito con sorgenti LED ad alta efficienza con tecnologia Chip On Board e driver. Il grado di protezione contro la penetrazione di polvere, corpi solidi e liquidi è IP20.

Characterized by the symmetrical cuts, Mia is a double emission wall lamp made from epoxy polyester powder coated aluminium and it is equipped with Chip On Board technology high efficiency LED light sources and driver. Its degree of protection against the penetration of dust, solid objects and liquids is IP20.



GAIA

PARETE / WALL

CODICE	W	Lm
A9-650.30	11	885

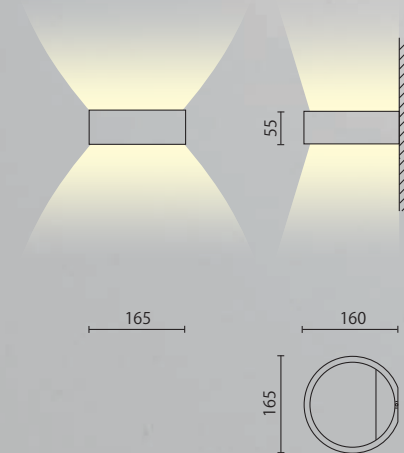







Un anello che compenetra nella superficie di supporto e diffonde una luce dai contorni delicati. Gaia è un apparecchio da parete biemissione realizzato in alluminio verniciato a polvere epossipoliestere stabilizzata ai raggi UV. Viene fornito con sorgenti LED ad alta efficienza e driver. Il grado di protezione contro la penetrazione di polvere, corpi solidi e liquidi è IP20.

A ring diffusing a delicate light. Gaia is a double emission wall lamp made from epoxy polyester powder coated aluminium stabilized with UV rays and it is equipped with Chip On Board technology high efficiency LED light sources and driver. Its degree of protection against the penetration of dust, solid objects and liquids is IP20.

	100°
TC	3000K
IP	20
CRI	>80
EEL	A+
RG	0
08	Bianco satinato



-  90°
-  TC 3000K
-  IP 44
-  CRI >80
-  EEI A+
-  RG 0
-  08 Bianco satinato

CODICE	W	Lm
A9.652.30	9	360

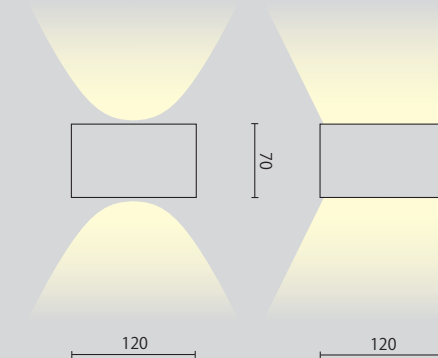

Armonia tra design e luce, Lynn è un apparecchio da parete biemissione realizzato in alluminio verniciato a polvere epossipoliestere stabilizzata ai raggi UV. Fornito di lenti concentriche, viene equipaggiato con sorgenti LED ad alta efficienza e driver. Il grado di protezione contro la penetrazione di polvere, corpi solidi e liquidi è IP44.

Balance between design and light, Lynn is a double emission wall lamp made from epoxy polyester powder coated aluminium stabilized with UV rays. It is equipped with concentric lenses, Chip On Board technology high efficiency LED light sources and driver. Its degree of protection against the penetration of dust, solid objects and liquids is IP44.

LYNN

PARETE / WALL





MAYA

PARETE / WALL

CODICE	W	Lm
A9-654.30	11	850

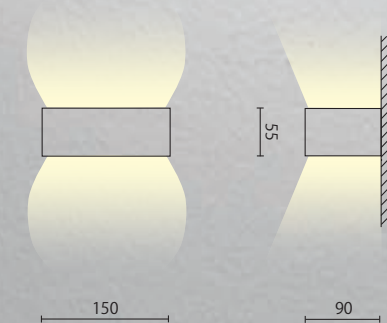

Apparecchio da parete biemissione dalle linee sinuose, Maya è realizzato in alluminio verniciato a polvere epossipoliestere stabilizzata ai raggi UV. Viene fornito con sorgenti LED ad alta efficienza e driver. Il grado di protezione contro la penetrazione di polvere, corpi solidi e liquidi è IP40.

Sinuous lines identify Maya, a double emission wall lamp made from epoxy polyester powder coated aluminium stabilized with UV rays. It is equipped with high efficiency LED modules and driver. Its degree of protection against the penetration of dust, solid objects and liquids is IP40.

	90°
TC	3000K
IP	40
CRI	>80
EEL	A+
RG	0
08	Bianco satinato



BEA

PARETE / PLAFONE / WALL / CEILING

Due corpi cilindrici che interagiscono tra loro attraverso un perno laterale, permettendo illimitate soluzioni di illuminazione. Bea è un apparecchio orientabile da parete/plafone monodiffusione realizzato in alluminio verniciato a polvere epossipoliestere stabilizzata ai raggi UV. Viene fornito con sorgenti LED ad alta efficienza a tecnologia Chip On Board e driver. Il grado di protezione contro la penetrazione di polvere, corpi solidi e liquidi è IP40.

Two cylindrical bodies which interact with one another to allow limitless lighting solutions thanks to a side pivot. Bea is an adjustable single emission light for wall or ceiling. It is made from epoxy polyester powder coated aluminium stabilized with UV rays and it is equipped with a Chip On Board technology high efficiency LED light source and driver. Its degree of protection against the penetration of dust, solid objects and liquids is IP40.

	40° (a richiesta 20°) (20° on request)
TC	3000K
IP	40
CRI	93
EEI	A+
RG	1
08	Bianco satinato

CODICE	W	Lm
A4-650.15.30	15	1320

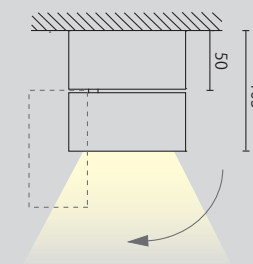

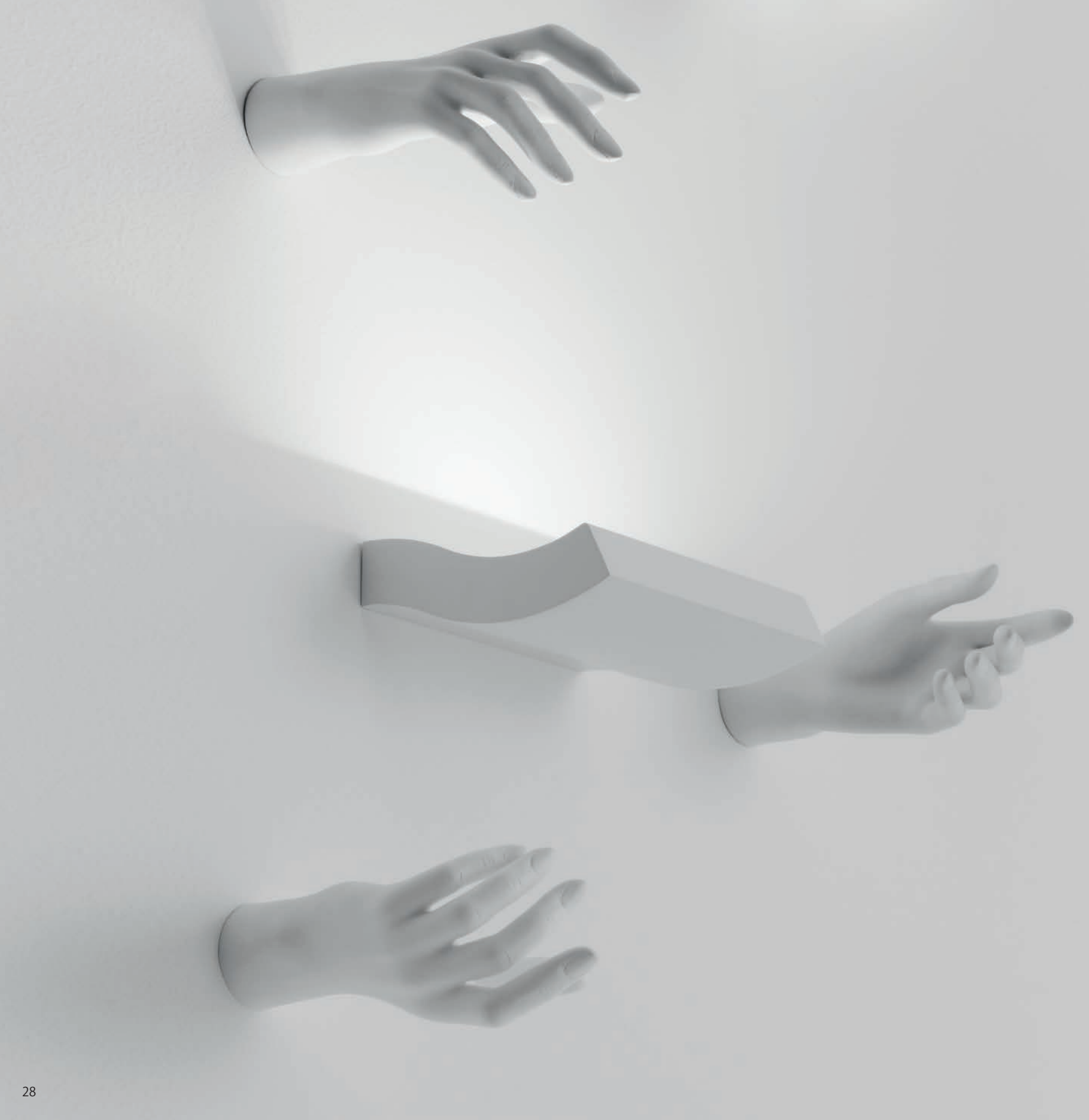

EMMA

PARETE / WALL

CODICE	W	Lm (3000K)
A9-620...	13	1640

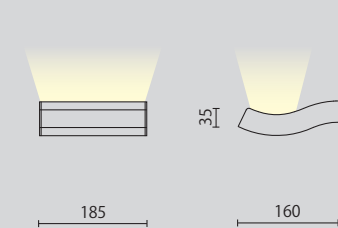

Forma sinuosa e leggera, Emma è un apparecchio da parete in estrusione di alluminio verniciato a polvere epossidica stabilizzata ai raggi UV. Dotato di schermo di protezione in cristallo, è equipaggiato con due moduli LED ad alta efficienza. Il grado di protezione contro la penetrazione di polvere, corpi solidi e liquidi è IP40.

Emma is a sinuous and light wall luminaire made from extruded epoxy powder coated aluminium stabilized with UV rays. It comes complete with a clear crystal screen, two high efficiency LED modules and driver. Its degree of protection against the penetration of dust, solid objects and liquids is IP40.

	110°
TC	3000K / 4000K
IP	40
CRI	>80
EEL	A++
RG	0
08	Bianco satinato



EMMA UP





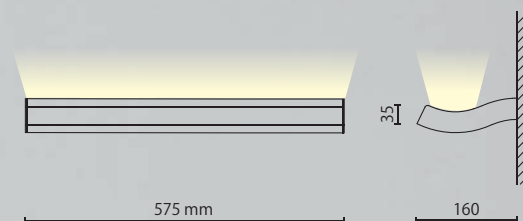

PARETE / WALL

CODICE	W	Lm (3000K)
A9-621...	23	3000



La flessuosità di un'onda che scaturisce dalla parete per illuminarla raffinatamente. Emma Up è un apparecchio monodiffusione da parete realizzato in alluminio estruso verniciato a polvere epossidica stabilizzata ai raggi UV ed equipaggiato con schermo di protezione in cristallo trasparente. Viene fornito con sorgenti LED ad alta efficienza e driver. Il grado di protezione contro la penetrazione di polvere, corpi solidi e liquidi è IP40.

A smooth wave flowing from the wall to tastefully enlighten the surfaces. Emma Up is a single emission wall light made from extruded epoxy polyester powder coated aluminium stabilized with UV rays. It is equipped with a transparent crystal screen, high efficiency LED modules and driver. Its degree of protection against the penetration of dust, solid objects and liquids is IP40.

	110°
	3000K / 4000K
	40
	>80
	A++
	0
	08 Bianco satinato



LISA

PARETE / WALL

Estremamente pulito e lineare, Lisa è un apparecchio da parete realizzato in alluminio verniciato a polvere epossidica stabilizzata a raggi UV. È equipaggiato con LED ad alta efficienza, non necessita di driver ed è dotato di schermo in policarbonato microprismato. Il grado di protezione contro la penetrazione di polvere, corpi solidi e liquidi è IP40.

Extremely well-finished and linear-shaped, Lisa is a wall lamp made from epoxy powder coated aluminium stabilized with UV rays. It is equipped with high efficiency LED modules and micro-prismatic polymethyl methacrylate screen. It does not require a driver. Its degree of protection against the penetration of dust, solid objects and liquids is IP40.



100°



3000K / 4000K



40



>80



A+



0



Bianco satinato

CODICE	W	Lm (3000K)
A9-626...	18	1560

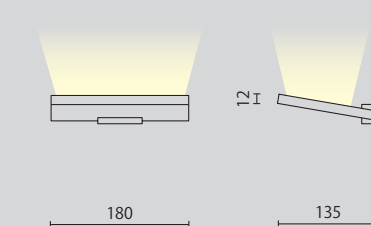



CODICE	W	Lm
A9-628.30	3	230

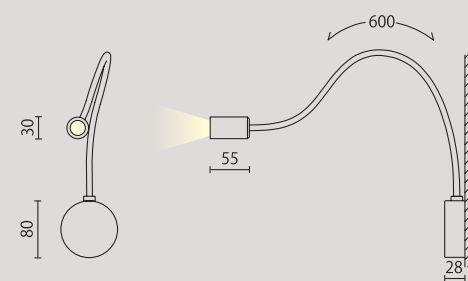

IRILED

PARETE / WALL

Duttile e trasformista, Iriled è un apparecchio da parete con corpo in alluminio anodizzato e asta flessibile direzionabile. Equipaggiato con LED ad alta efficienza, è possibile variare il fascio luminoso agendo sul supporto lente. Il grado di protezione contro la penetrazione di polvere, corpi solidi e liquidi è IP40.

Pliable and transforming, Iriled is a wall lamp made from natural or black anodized aluminium with a flexible beam. It is equipped with a high efficiency LED light source whose beam angle can be adjusted by moving the lens support. Its degree of protection against the penetration of dust, solid objects and liquids is IP40.

 37° / 73°

 TC 3000K

 IP 40

 CRI >80

 EEI A+

 RG 1

 05 Nero anodizzato

 20 Anodizzato naturale



EK CUBO PLAFONE

CODICE	W	Lm (3000K)	IP
A4-613...	15	1350	43

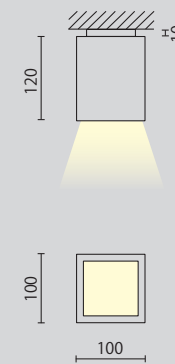

Decox, elettrodomestici



	100°
TC	3000K / 4000K
IP	(vedi tabella) / (see table)
CRI	>80
EEL	A+
RG	0
	Bianco satinato/Nero opaco
	Bianco satinato

EK CUBO

PARETE / PLAFONE / WALL / CEILING

Design compatto ed essenziale per renderlo adattabile alle diverse esigenze in ambienti residenziali, questo apparecchio è realizzato in alluminio verniciato a polvere epossipoliestere con diffusore in acridite fresato e satinato. È corredato di LED ad alta efficienza e non necessita di driver. Il grado di protezione contro la penetrazione di polvere, corpi solidi e liquidi varia da IP20 a IP43.

A compact and basic design characterizes this product, which can meet the multiple lighting needs of homes. Ek Cubo is a wall and ceiling lamp made from epoxy polyester powder coated aluminum and it is equipped with a high efficiency LED light source. This product does not require a driver. Its degree of protection against the penetration of dust, solid objects and liquids varies from IP20 to IP43.

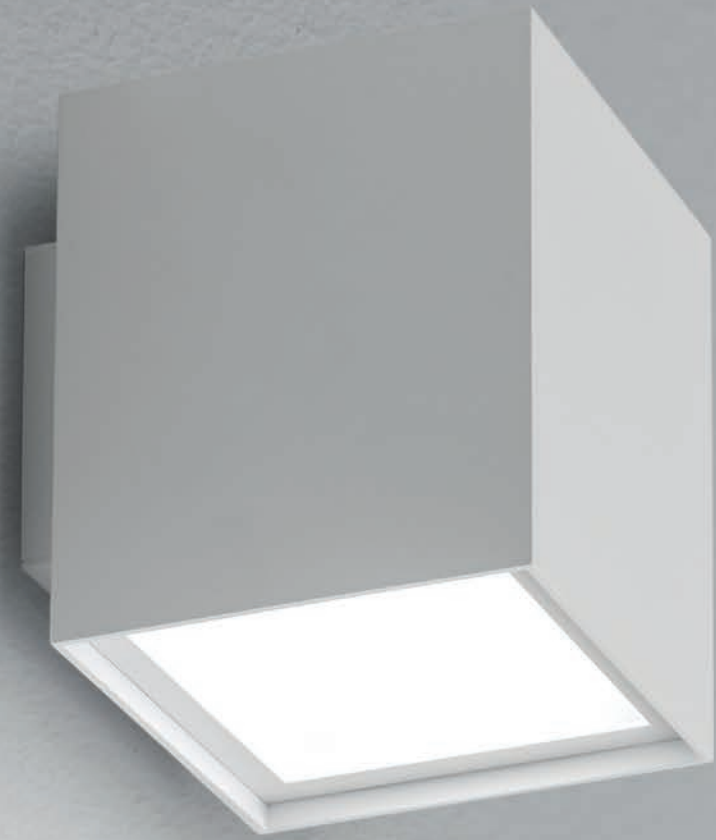

EK CUBO PARETE

CODICE	W	Lm (3000K)	IP
A9-613...	15	1350	20

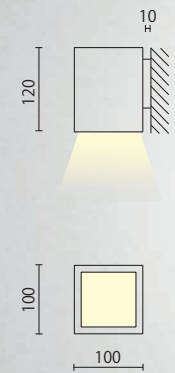

MUR Ø120

CODICE	W	Lm (3000K)	
A4-600.212...	2x12	2x1615	40° (a richiesta 24°) (24° on request)
A4-600.217...	2x17	2x2240	40° (a richiesta 24°) (24° on request)
A4-600.223...	2x23	2x3025	40° (a richiesta 24°) (24° on request)

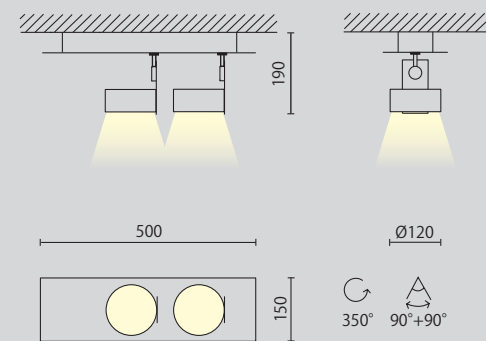

MUR Ø60

CODICE	W	Lm (3000K)	
A4-202.2...	2x9	2x1115	30°

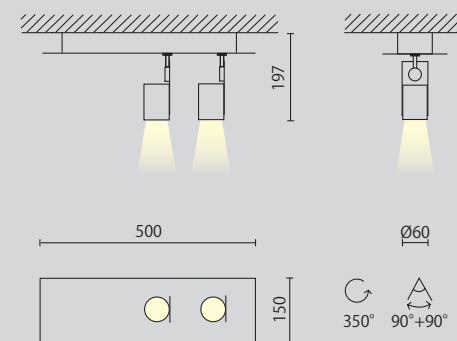

	(vedi tabella) / (see table)
TC	3000K / 4000K
IP	40
CRI	93 (a richiesta >80) (>80 on request)
EEL	A++
RG	1
08 02	Bianco satinato/Nero opaco
02	Nero opaco
08	Bianco satinato

MUR

PARETE / PLAFONE / WALL / CEILING

Linee sottili ma decise per questo apparecchio da parete/plafone, la cui particolare orientabilità permette di assumere le più diverse posizioni per valorizzare al meglio oggetti e dettagli. Realizzato in alluminio e acciaio verniciato a polvere epossipoliestere, è equipaggiato con LED ad alta efficienza e driver. La base può essere rettangolare con 2 sorgenti luminose o quadrata con 4 sorgenti. Il grado di protezione contro la penetrazione di polvere, corpi solidi e liquidi è IP40.

Subtle but powerful lines identify these wall/ceiling fixtures, which can be angled into infinite positions to enhance objects and details. Mur luminaires are made from epoxy polyester powder coated aluminium and steel. They are equipped with a high efficiency LED light source and driver. The base can be rectangular with two light sources or square-shaped with four sources. Their degree of protection against the penetration of dust, solid objects and liquids is IP40.



MUR Ø120

CODICE	W	Lm (3000K)	Icon
A4-602.412...	4x12	4x1615	40° (a richiesta 24°) (24° on request)
A4-602.417...	4x17	4x2240	40° (a richiesta 24°) (24° on request)
A4-602.423...	4x23	4x3025	40° (a richiesta 24°) (24° on request)

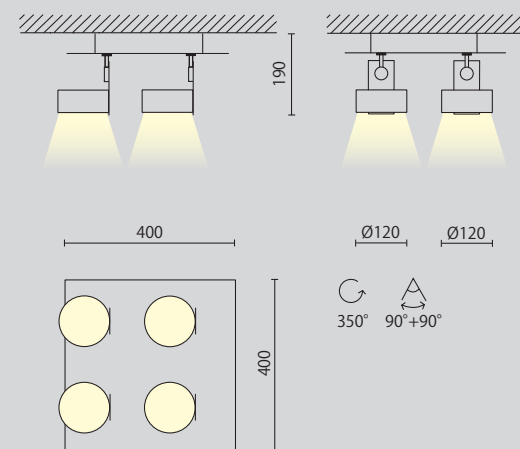

MUR Ø60

CODICE	W	Lm (3000K)	Icon
A4-203.4...	4x9	4x1115	30°

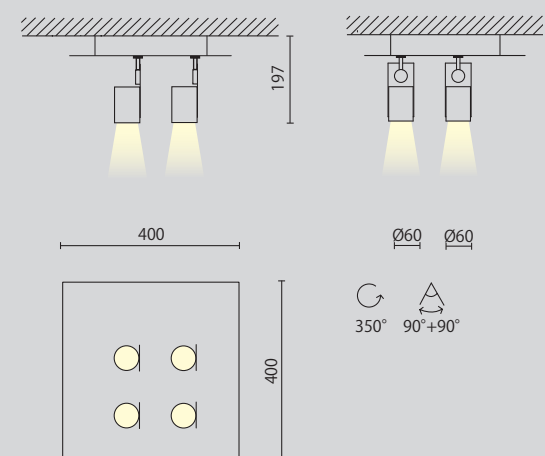



FUSION

PARETE / WALL

Apparecchio da parete bidiffusione dalla linea discreta ed essenziale, Fusion viene fornito con sorgente LED ad alta efficienza. Realizzato in alluminio estruso verniciato a polvere epossipoliestere fornito di diffusore opalino, si installa a parete mediante l'utilizzo di accessori in acciaio zincato inclusi. Il grado di protezione contro la penetrazione di polvere, corpi solidi e liquidi è IP40. L'apparecchio è fornito di driver. Possibilità di sostituire il diffusore opalino con una lente di fascio 30° che, riducendo la luminanza diretta dell'apparecchio, rende Fusion adatto all'installazione in ambienti in cui viene richiesto un UGR<19 (normativa UNI-11165 e UNI 12464-1), quali uffici o postazioni con videotermini.

Double emission wall fixture characterized by an essential and nonintrusive line, Fusion is made from epoxy polyester powder coated aluminium and it is equipped with a frosted light diffuser, high efficiency LED modules and driver. 30° lens reducing the luminaire's direct lighting (UGR<19, standards UNI-11165 and EN 12464-1) available on request. Its degree of protection against the penetration of dust, solid objects and liquids is IP40.

FUSION PRO BIDIFFUSIONE

CODICE	W	Lm (3000K)
A9-617.2.028...	2x10	2x1320
A9-617.2.056...	2x20	2x2640
A9-617.2.084...*	2x30	2x3960
A9-617.2.112...*	2x40	2x5280
LE001-30/100**	lente fascio 30° / lens 30°	

/DIMM2 dimmerabile protocollo DALI

/DIMM3 dimmerabile switch-DIM

*doppia accensione, **codice al metro / *double switch, **code per meter

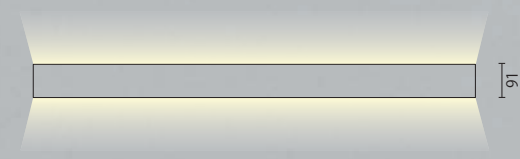

mm	codice
330	A9-617.2.028
581	A9-617.2.056
861	A9-617.2.084
1141	A9-617.2.112



	↓70° / ↑120°
TC	3000K / 4000K
IP	40
CRI	>80
EEL	A++
RG	0
08	Bianco satinato

FUSION PRO LIGHT BIDIFFUSIONE

CODICE	W	Lm (3000K)
A9-616.2.028...	2x9	2x1100
A9-616.2.056...	2x18	2x2200
A9-616.2.084...*	2x27	2x3300
A9-616.2.112...*	2x35	2x4400
LE001-30/100**	lente fascio 30°	

/DIMM2 dimmerabile protocollo DALI

/DIMM3 dimmerabile switch-DIM



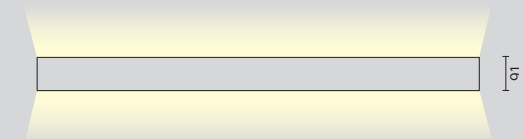

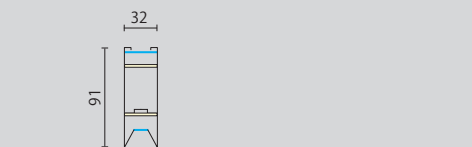
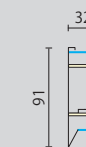

*doppia accensione, **codice al metro / *double switch, **code per meter



mm	codice
330	A9-616.2.028
581	A9-616.2.056
861	A9-616.2.084
1141	A9-616.2.112





-  360°
-  TC 3000K / 4000K
-  IP 40
-  CRI >80
-  EEI A++
-  RG 0
-  08 Bianco satinato

SHARP

PARETE / PLAFONE / WALL / CEILING

Una forte personalità espressa da curve eleganti ed armoniose. Sharp, apparecchio da parete o plafone a luce diffusa, accosta la bellezza estetica ad elevate prestazioni e ad un notevole risparmio energetico. Realizzato in acciaio verniciato a polvere epossipoliestere con diffusore in polietilene satinato, viene fornito con sorgenti LED ad alta efficienza e driver. Il grado di protezione contro la penetrazione di polvere, corpi solidi e liquidi è IP40.

A strong personality expressed by elegant and harmonious curves. Sharp is a wall/ ceiling luminaire for diffuse lighting which relates beauty to high performances and considerable long-term energy savings. It is made from epoxy polyester powder coated aluminium and it is equipped with a frosted polyethylene diffuser, a high efficiency LED light source and driver. Its degree of protection against the penetration of dust, solid objects and liquids is IP40.

CODICE	W	Lm (3000K)
A4-630.036...	36	4400
A4-631.048...	48	6000

/DIMM2 dimmerabile protocollo DALI
/DIMM3 dimmerabile switch-DIM

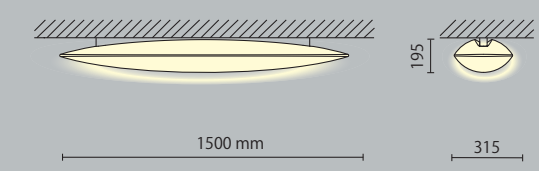



WHEEL

Arch. Rocco Este

TERRA / FLOORLAMP





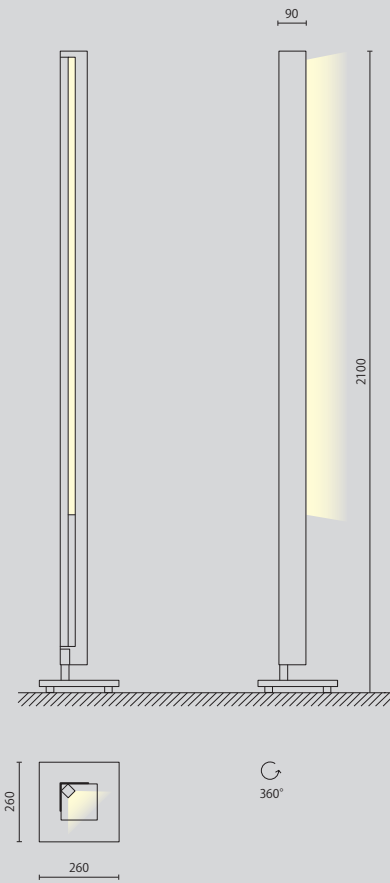
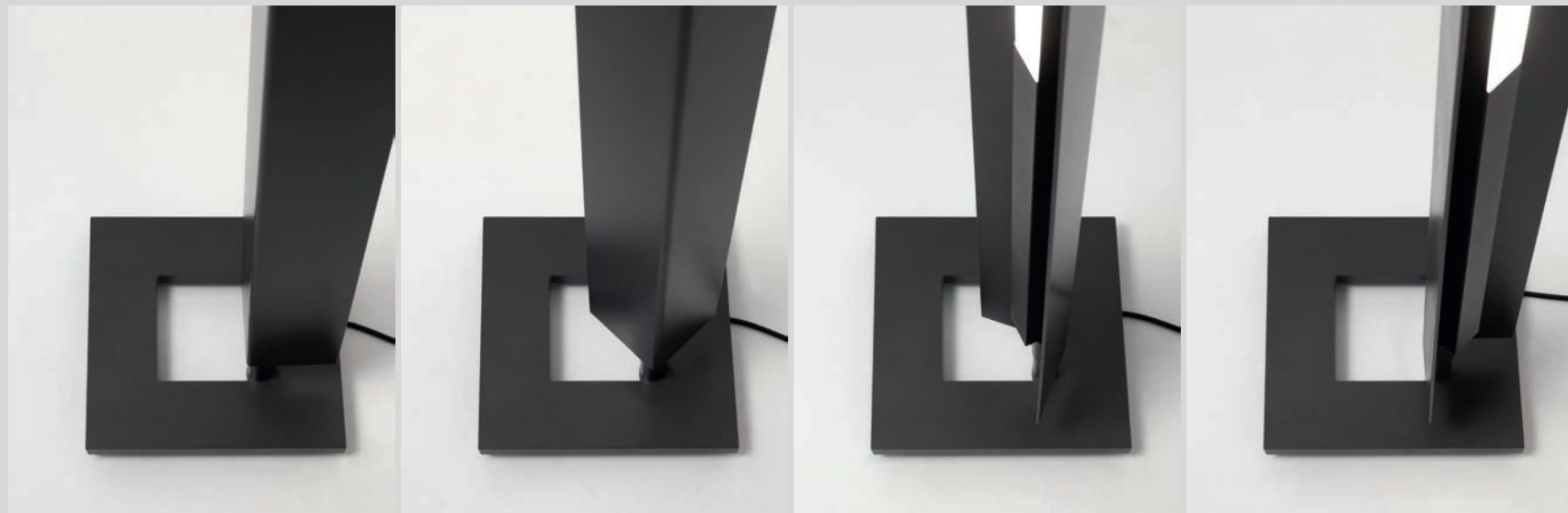

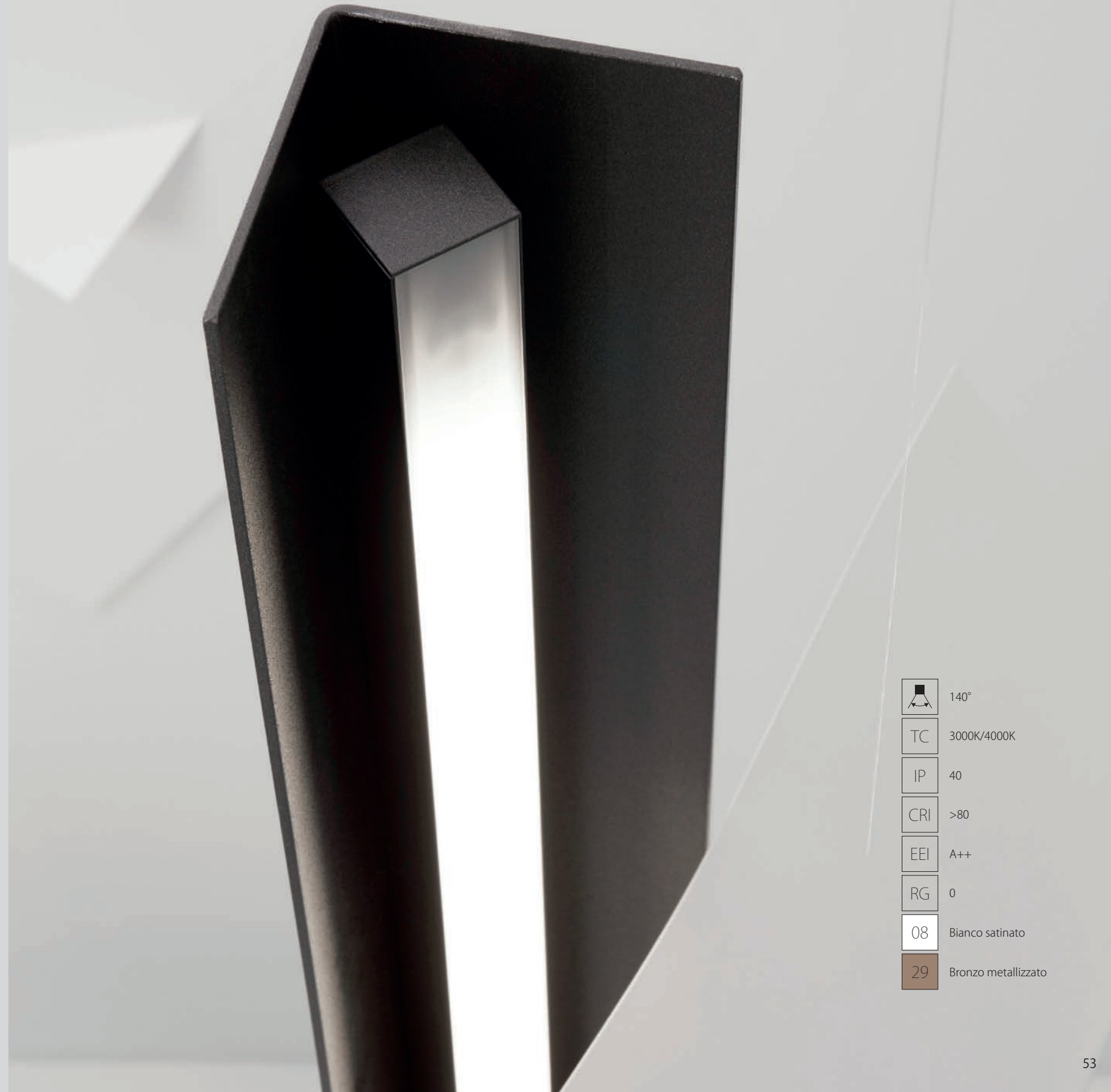

Design minimale e forme squadrate contraddistinguono questa lampada da terra orientabile dalla presenza discreta ed elegante. Fornita di moduli LED ad alta efficienza, Wheel è realizzata in acciaio ed alluminio verniciato a polvere epossipoliestere stabilizzata ai raggi UV. Grazie alla posizione nascosta dei LED, inseriti in un'estrusione di alluminio con schermo diffusore in policarbonato opalino, l'emissione luminosa risulta essere diffusa e confortevole. L'apparecchio è dotato di driver ed è fornito con cavo e spina schuko. Il grado di protezione contro la penetrazione di polvere, corpi solidi e liquidi è IP40.

A minimal and boxy design distinguishes this adjustable floor lamp with a discreet presence that fits elegantly in different contexts. Furnished with high efficiency LED modules, Wheel is made from steel and epoxy polyester powder coated aluminium stabilized with UV rays. Thanks to the concealed position of the LED lights and to the opal polycarbonate diffuser, the light emission is diffused and cheering. The fixture is provided with driver, cable and schuko plug. Its degree of protection against the penetration of dust, solid objects and liquids is IP40.



CODICE	W	Lm (3000K)
A3-400...	27	3650



-  140°
-  TC 3000K/4000K
-  IP 40
-  CRI >80
-  EEI A++
-  RG 0
-  08 Bianco satinato
-  29 Bronzo metallizzato

SOSPENSIONI
HANGINGS

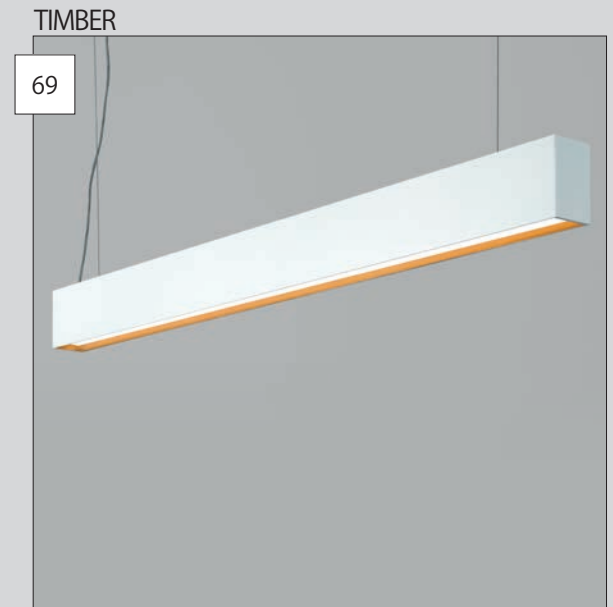



Abitazione privata, Varese

MISSY

SOSPENSIONI / HANGINGS

Apparecchio a sospensione con corpo in alluminio tornito verniciato a polvere epossipoliestere, si distingue per il design del diffusore, che acquista leggerezza visiva grazie al gioco di luce ed ombra creato sulla sua superficie da un taglio strategico.

Equipaggiato con sorgente a LED ad alta efficienza a tecnologia Chip On Board, è disponibile in due misure, piccola e grande, e in cinque versioni, da 13W, 12W, 17W, 25W e 33W. I modelli da 13W e 25W non necessitano di driver e, essendo privi di parabola, emettono una luce diffusa. Le versioni da 12W, 17W e 33W, invece, sono dotate di parabola metallizzata da 50° e di driver. A richiesta vengono fornite parabole da 16° per Missy Piccolo e da 20° per Missy Grande. L'installazione a sospensione avviene mediante cavetti di acciaio zincato dotati di dispositivi a regolazione rapida. Missy Grande è disponibile anche in versione bidiffusione senza driver. Il grado di protezione contro la penetrazione di polvere, corpi solidi e liquidi è IP40.

Hanging lamp made from epoxy polyester powder coated aluminium, Missy has a distinguished design. A strategic cut on its surface creates an interesting interaction of light and shade, giving airiness to the lamp structure. Complete with a Chip On Board technology high efficiency LED light source, it is available in small and large size and in five different wattages. No driver is needed for the 13W and the 25W models, which do not have a reflector, while the 12W, 17W and 33W versions are furnished with a 50° reflector and driver. 16° and 20° reflectors available on request. Missy Grande can be demanded also in the double emission version without driver. Its degree of protection against the penetration of dust, solid objects and liquids is IP40.



MISSY PICCOLO

CODICE	W	Lm (3000K)	
A8-640.13...	13	1100	110°
A8-641.15...	12	1880	50° (a richiesta 16°) (16° on request)
A8-641.20...	17	2620	50° (a richiesta 16°) (16° on request)

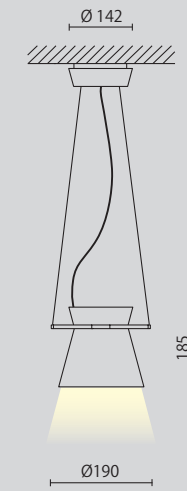

	(vedi tabella) / (see table)
TC	3000K / 4000K
IP	40
CRI	>80
EEL	A+ (13W-25W) A++ (12W-17W-33W)
RG	1
03	Nero lucido
08	Bianco satinato

MISSY GRANDE

CODICE	W	Lm (3000K)	
A8-645.25...	25	2000	110°
A8-646.35...	33	4400	50° (a richiesta 20°) (20° on request)

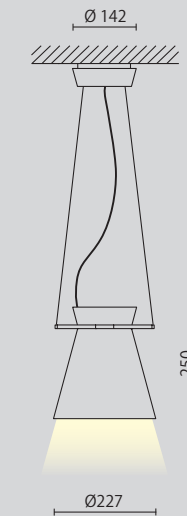



MISSY GRANDE BIDIFFUSIONE

CODICE	W	Lm (3000K)	
A8-648.2...	13+25	1100+2000	110°

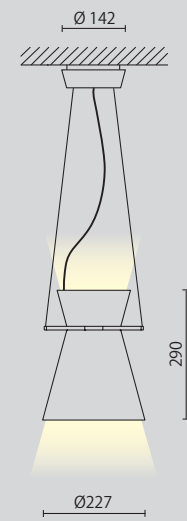

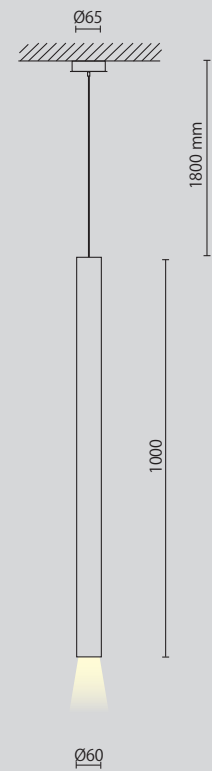

Cod. A8-650.100

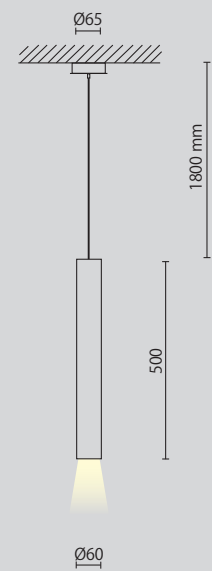

Cod. A8-650.050











CODICE	W	Lm (3000K)
A8-650.050..	7	1040
A8-650.100..	7	1040

MERY

SOSPENSIONI / HANGINGS

Mery è un apparecchio a sospensione dal design minimale, ma in grado di donare personalità e originalità allo spazio in cui viene inserito. Realizzato in alluminio verniciato a polvere epossipoliestere, viene fornito con sorgenti LED ad alta efficienza con tecnologia Chip On Board e driver. È possibile richiedere l'anello interno nelle colorazioni nero, oro o bianco. Il grado di protezione contro la penetrazione di polvere, corpi solidi e liquidi è IP40.

Mery is a hanging luminaire that can add personality and freshness to any space despite its minimal design. It is made from epoxy polyester powder coated aluminium and it is equipped with a Chip On Board technology high efficiency LED light source and driver. The inner ring is available in black, white and gold. Its degree of protection against the penetration of dust, solid objects and liquids is IP40.

-  40°
-  3000K / 4000K
-  40
-  >80
-  A++
-  1
-  02 Nero opaco
-  08 Bianco satinato
-  A AN001.08 Anello bianco / White ring
AN001.13 Anello oro / Gold ring





FROY



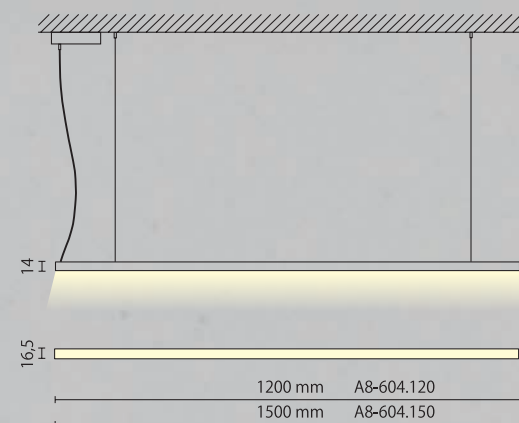





SOSPENSIONI / HANGINGS









CODICE	W	Lm (3000K)
A8-604.120...	30	3000
A8-604.150...	38	3750

Affusolato e leggero, Froy è un apparecchio a sospensione in alluminio estruso verniciato a polvere epossipoliestere con diffusore opalino. Viene fornito con sorgenti LED ad alta efficienza e driver. L'installazione a sospensione avviene mediante cavetti di acciaio zincato dotati di dispositivi a regolazione rapida. Il grado di protezione contro la penetrazione di polvere, corpi solidi e liquidi è IP40.

Thin and airy, Froy is a hanging luminaire made from epoxy polyester powder coated aluminium. It is equipped with an opal diffuser, high efficiency LED modules and driver. The lamp is suspended with galvanized steel cables (not included) with quick-adjust regulation devices. Its degree of protection against the penetration of dust, solid objects and liquids is IP40.

-  105°
-  TC 3000K / 4000K
-  IP 40
-  CRI >80
-  EEI A+
-  RG 0
-  02 Nero opaco
-  09 Bianco opaco



-  360°
-  TC 3000K / 4000K
-  IP 40
-  CRI >80
-  EEI A++
-  RG 0
-  08 Bianco satinato

CODICE	W	Lm (3000K)
A8-630.036...	36	4400
A8-631.048...	48	6000

/DIMM2 dimmerabile protocollo DALI
 /DIMM3 dimmerabile switch-DIM

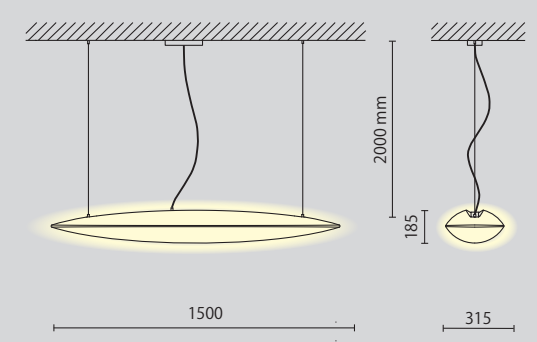

SHARP

SOSPENSIONI / HANGINGS



Un volume dalle linee morbide, ma dal forte carattere, enfatizzato dal cavo di alimentazione rosso. Sharp è una sospensione a luce diffusa in grado di aggiungere personalità agli ambienti. Realizzata in alluminio verniciato a polvere epossipoliestere con diffusore in polietilene satinato, è equipaggiata con sorgente LED ad alta efficienza e driver. L'installazione a sospensione avviene mediante cavetti di acciaio zincato dotati di dispositivi a regolazione rapida. Il grado di protezione contro la penetrazione di polvere, corpi solidi e liquidi è IP40.

A soft volume with a strong personality emphasized by the red power cable. Sharp is a hanging luminaire for diffuse lighting. It is made from epoxy polyester powder coated aluminium and it is equipped with a frosted polyethylene diffuser, a high efficiency LED light source and driver. The lamp is suspended with galvanized steel cables (not included) with quick-adjust regulation devices. Its degree of protection against the penetration of dust, solid objects and liquids is IP40.



	↓75° (↑100°)
TC	3000K / 4000K
IP	40
CRI	>80
EEL	A++
RG	0

TIMBER

SOSPENSIONI / HANGINGS

La semplicità della forma unita alla possibilità di personalizzare il prodotto scegliendo il colore degli inserti (oro, bianco o nero). Timber è una sospensione mono o biemissione completa di moduli a LED ad alta efficienza. Fornita di driver, è realizzata in alluminio estruso verniciato a polvere epossipoliestere con diffusore in policarbonato opalino. L'installazione a sospensione avviene mediante cavetti di acciaio zincato dotati di dispositivi a regolazione rapida. L'apparecchio è completo di terminali di chiusura e rosone con cavo di alimentazione, tripolare per la versione monoemissione, quadripolare per le versioni biemissione e DIMM3 (switch-DIM) e pentapolare per le versioni DIMM2 (DALI) ed emergenza. Disponibile nelle versioni emergenza tipo SA, autonomia 1h e dimmerabile DALI/switch-dim. Il grado di protezione contro la penetrazione di polvere, corpi solidi e liquidi è IP40.

A basic shape combined with the possibility of customizing the product by choosing the colour of the inserts (gold, black or white). Timber is a single and double emission hanging luminaire complete with high efficiency LED modules and driver. It is made from epoxy polyester powder coated aluminium and it is equipped with an opal polycarbonate diffuser. The lamp is suspended with galvanized steel cables with quick-adjust regulation devices. End caps, suspension and supply cables are included. SA emergency version (1 hour of autonomy) and switch-dim/DALI dimmable version available on request. Its degree of protection against the penetration of dust, solid objects and liquids is IP40.



TIMBER PRO LIGHT MONOEMISSIONE

CODICE	W	Lm (3000K)
A8-660PL.112...	35	4400
A8-660PL.140...	44	5500

/DIMM2 dimmerabile protocollo DALI
 /DIMM3 dimmerabile switch-DIM
 /EM modulo in emergenza (a richiesta / *on request*)

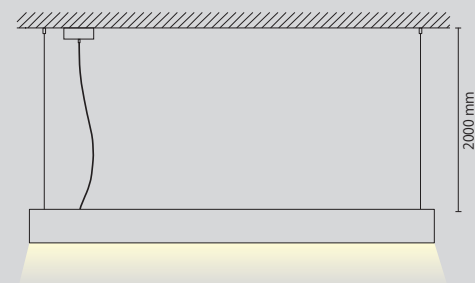

mm	codice
1129	A8-660PL.112
1409	A8-660PL.140

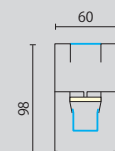

TIMBER PRO LIGHT BIEMISSIONE

CODICE	W	Lm (3000K)
A8-660PL.2.112...	2x35	2x4400
A8-660PL.2.140..	2x44	2x5500

/DIMM2 dimmerabile protocollo DALI
 /DIMM3 dimmerabile switch-DIM
 /EM modulo in emergenza (a richiesta / *on request*)
 doppia accensione / *double switch*

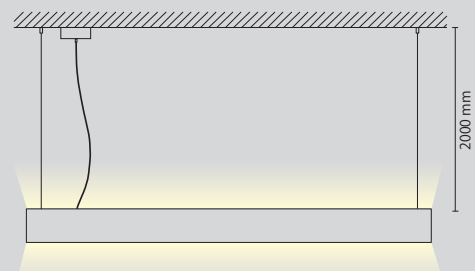

mm	codice
1129	A8-660PL.2.112
1409	A8-660PL.2.140

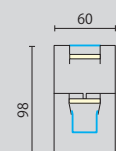

COLORE PROFILO BODY COLOUR

- 02 Nero opaco
- 08 Bianco satinato
- 46 Rovere sbiancato

COLORE INSERTO COLOURED INSERT

- T002 Nero opaco
- T008 Bianco satinato
- T013 Oro





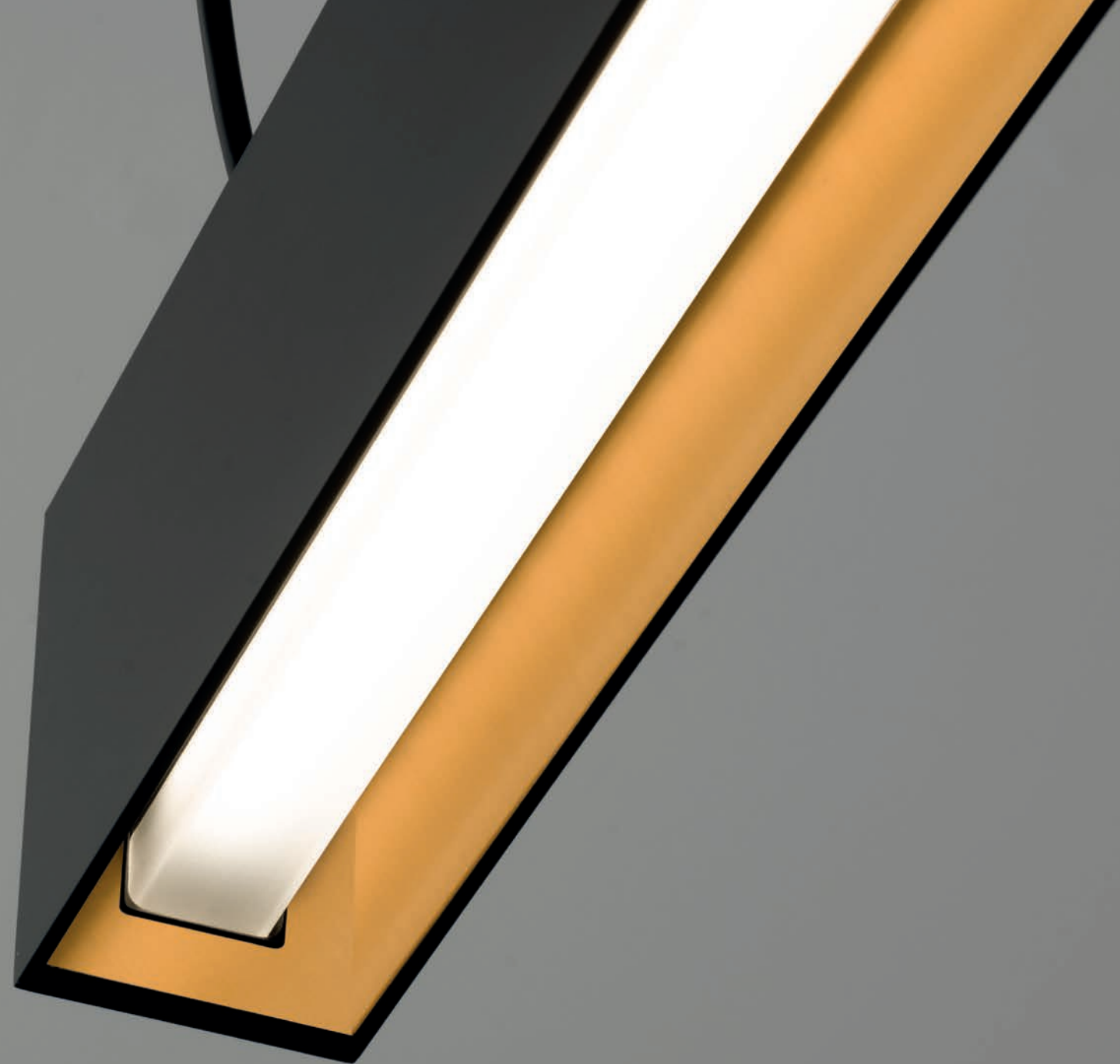

TIMBER SOFT MONOEMISSIONE

CODICE	W	Lm (3000K)
A8-660S.112...	24	3250
A8-660S.140...	30	4060

/DIMM2 dimmerabile protocollo DALI
 /DIMM3 dimmerabile switch-DIM
 /EM modulo in emergenza (a richiesta) / *(on request)*

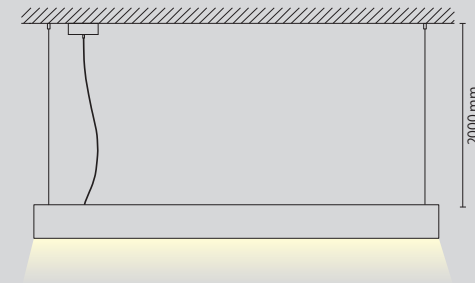

mm	codice
1129	A8-660S.112
1409	A8-660S.140

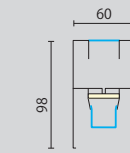

TIMBER SOFT BIEMISSIONE

CODICE	W	Lm (3000K)
A8-660S.2.112...	2x24	2x3250
A8-660S.2.140...	2x30	2x4060

/DIMM2 dimmerabile protocollo DALI
 /DIMM3 dimmerabile switch-DIM
 /EM modulo in emergenza (a richiesta) / *(on request)*
 doppia accensione / *double switch*

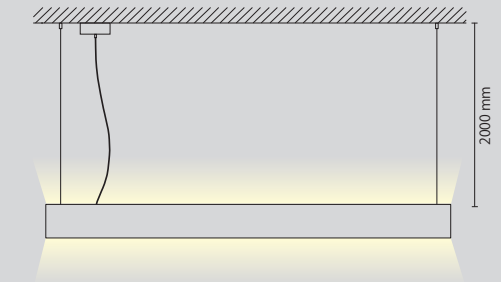

mm	codice
1129	A8-660S.2.112
1409	A8-660S.2.140

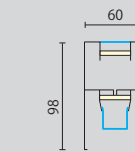



FUSION

SOSPENSIONI / HANGINGS

Il concetto di linearità applicato ad un apparecchio a sospensione bidiffusione. Fusion è realizzato in alluminio estruso verniciato a polvere epossipoliestere e viene fornito completo di sorgente LED ad alta efficienza. L'installazione a sospensione avviene mediante cavetti di acciaio zincato dotati di dispositivi a regolazione rapida. Possibilità di sostituire il diffusore opalino con una lente di fascio 30° che, riducendo la luminanza diretta dell'apparecchio, rende Fusion adatto all'installazione in ambienti in cui viene richiesto un UGR<19 (normativa UNI-11165 e UNI 12464-1), quali uffici o postazioni con videoterminali. Il grado di protezione contro la penetrazione di polvere, corpi solidi e liquidi è IP40.

The concept of linearity applied to a hanging double diffusion lamp. Fusion is made from epoxy polyester powder coated aluminium and it is equipped with a frosted light diffuser, high efficiency LED modules and driver. The lamp is suspended with galvanized steel cables (not included) with quick-adjust regulation devices. 30° lens reducing the luminaire's direct lighting (UGR<19, standards UNI-11165 and EN 12464-1) available on request. Its degree of protection against the penetration of dust, solid objects and liquids is IP40.

FUSION PRO BIDIFFUSIONE

CODICE	W	Lm (3000K)
A8-607.2.112...	2x40	2x5280
A8-607.2.140...	2x50	2x6600
LE001-30/100*	lente fascio 30° / lens 30°	

/DIMM2 dimmerabile protocollo DALI

/DIMM3 dimmerabile switch-DIM

doppia accensione, *codice al metro / double switch, *code per meter

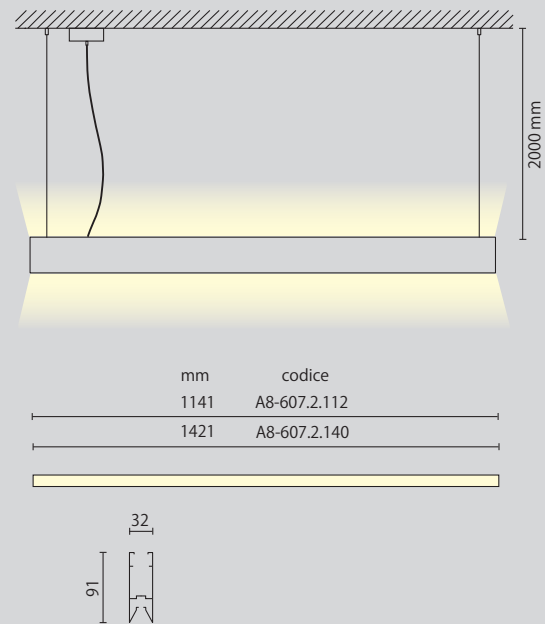

FUSION PRO LIGHT BIDIFFUSIONE

CODICE	W	Lm (3000K)
A8-606.2.112...	2x35	2x4400
A8-606.2.140...	2x44	2x5500
LE001-30/100*	lente fascio 30° / lens 30°	

/DIMM2 dimmerabile protocollo DALI

/DIMM3 dimmerabile switch-DIM

doppia accensione, *codice al metro / double switch, *code per meter

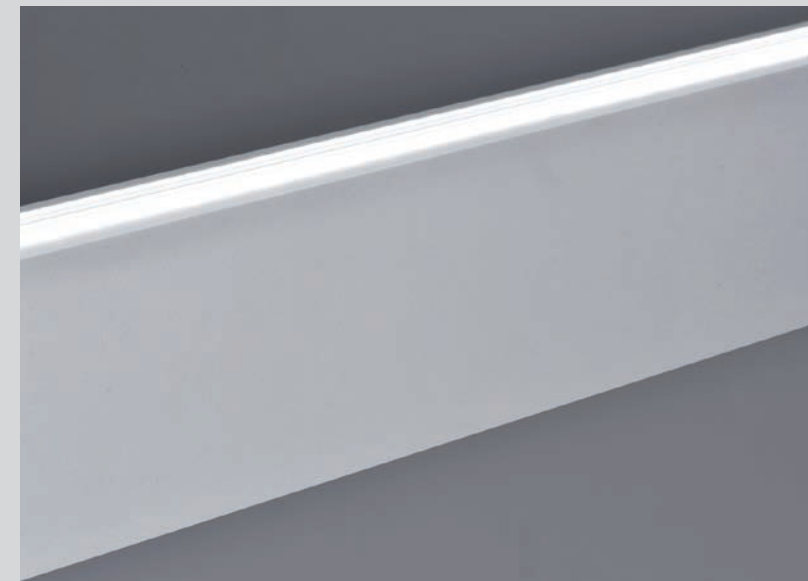
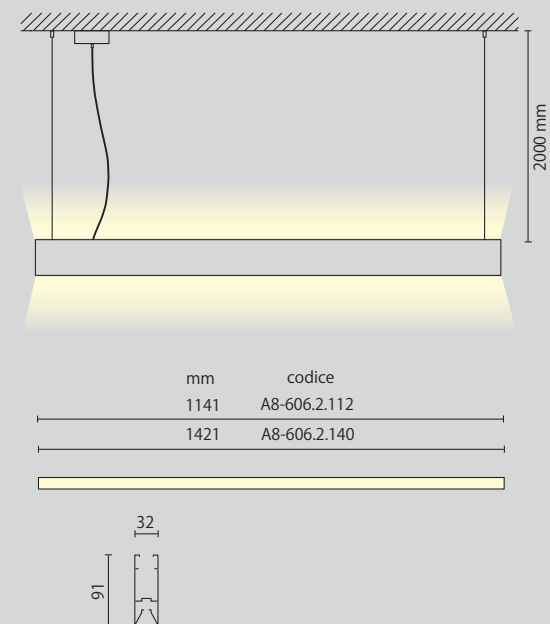

Diffusore opalino
Frosted light diffuser



Lente fascio 30°
30° lens

	↓70°/↑120°
TC	3000K / 4000K
IP	40
CRI	>80
EEL	A++
RG	0
08	Bianco satinato

PROIETTORI/BINARI
SPOTLIGHTS/TRACKS

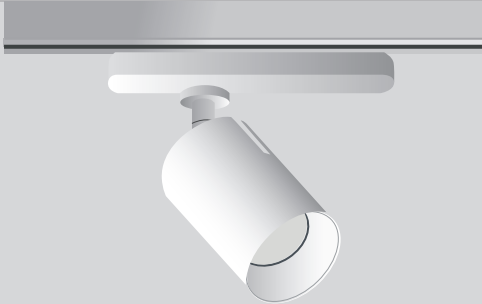

MIKE

83



MIKE GRANDE

91



TOV

95



MUR

97

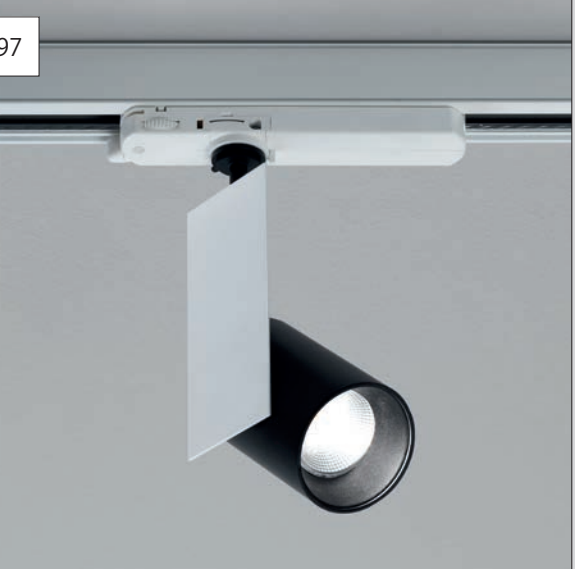

ARCO

103



ZETA

109



HARRY

113



DUE (BINARI / TRACKS)

117





MIKE

PROIETTORI / SPOTLIGHTS

Un taglio estetico e funzionale interrompe la superficie geometricamente perfetta di Mike, proiettore orientabile da parete/plafone o binario elettrificato trifase. Realizzato in alluminio pressofuso, è completo di sorgente LED ad alta efficienza con tecnologia Chip On Board. Le versioni da 230V non necessitano di driver. Su richiesta è possibile cambiare il colore dell'anello interno, normalmente nero, scegliendo tra i colori bianco o oro. Nella versione a binario l'adattatore elettrico trifase è incluso. Il grado di protezione contro la penetrazione di polvere, corpi solidi e liquidi è IP40.

A functional yet aesthetic cut interrupts the perfect surface of Mike, which is an adjustable spotlight for wall/ceiling or three circuit track. This product is made from die-cast aluminium and it is complete with a Chip On Board technology high efficiency LED light source. The 230V versions do not need the driver. The inner ring is available in black, white and gold. The track version includes the three phase converter. Its degree of protection against the penetration of dust, solid objects and liquids is IP40.

MIKE DA BINARIO

CODICE	W	Lm (3000K)
A2-609.12.../D	12	1470

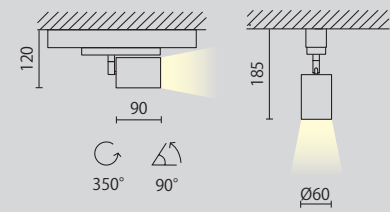

 40° (a richiesta 20°)
(20° on request)

TC 3000K / 4000K

IP 40

CRI 93 (a richiesta >80)
(>80 on request)
>80 (230V)

EEL A++ / A+ (230V)

RG 1

02 Nero opaco

08 Bianco satinato

A AN001.08 Anello bianco / White ring
AN001.13 Anello oro / Gold ring



MIKE 230V

CODICE	W	Lm (3000K)
A2-610.08AC...	8	704

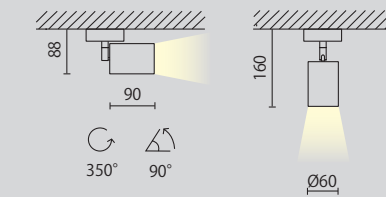

MIKE 230V DA BINARIO

CODICE	W	Lm (3000K)
A2-610.08AC.../D	8	704

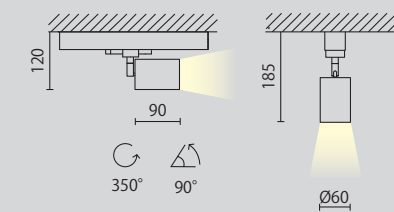





MIKE GRANDE

PROIETTORI / SPOTLIGHTS

La semplicità definisce Mike Grande, proiettore orientabile sui due assi che può essere applicato sia a parete/plafone sia a binario elettrificato trifase. Realizzato in alluminio pressofuso, è completo di sorgente LED ad alta efficienza con tecnologia Chip On Board. Le versioni da 230V non necessitano di driver. Su richiesta è possibile cambiare il colore dell'anello interno, normalmente nero, scegliendo tra i colori bianco o oro. Il grado di protezione contro la penetrazione di polvere, corpi solidi e liquidi è IP20 (15W) o IP40 (17W - 23W - 31W).

Simplicity defines Mike Grande, an adjustable spotlight for wall/ceiling or three circuit track. This product is made from die-cast aluminium and it is complete with a Chip On Board technology high efficiency LED light source. The 230V versions do not need the driver. The inner ring is available in black, white and gold. Its degree of protection against the penetration of dust, solid objects and liquids is IP20 (15W) or IP40 (17W - 23W - 31W).

MIKE GRANDE DA BINARIO

CODICE	W	Lm (3000K)
A2-612.17.../D	17	2240
A2-612.22.../D	23	2830
A2-612.31.../D	31	3575

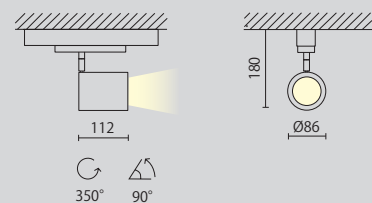

MIKE GRANDE 230V DA BINARIO



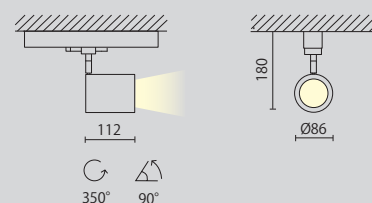



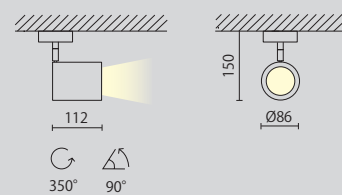

CODICE	W	Lm (3000K)
A2-612.15AC.../D	15	1350



MIKE GRANDE 230V

CODICE	W	Lm (3000K)
A2-612.15AC...	15	1350



-  36° (a richiesta 15° e 50°)
(15° and 50° on request)
-  TC 3000K / 4000K
-  IP 20 (15W) / 40 (17W-23W-31W)
-  CRI 93 (a richiesta >80)
(>80 on request)
-  EEI A+
-  RG 1
-  02 Nero opaco
-  08 Bianco satinato
-  A AN002.08 Anello bianco / White ring
AN002.13 Anello oro / Gold ring



TOV DA BINARIO

CODICE	W	Lm (3000K)
A2-209.../D	10	1320

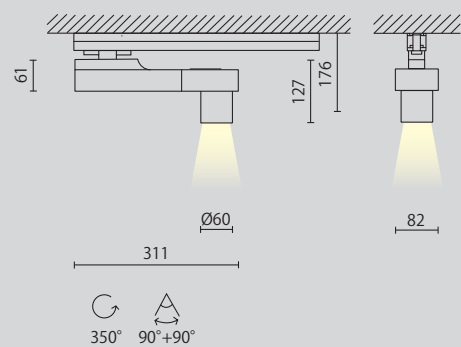

TOV

CODICE	W	Lm (3000K)
A2-209...	10	1320

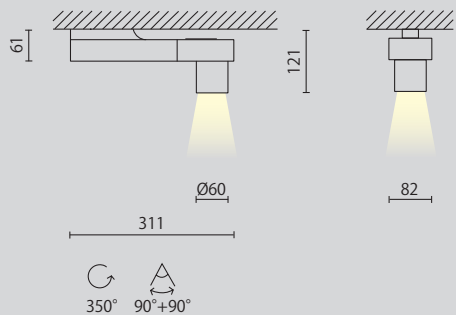









TOV

PROIETTORI / SPOTLIGHTS

Sobrio nella sua singolarità, Tov è un proiettore da parete/plafone o da binario orientabile sui due assi di 350° e 180°. Realizzato in alluminio pressofuso verniciato a polvere epossipoliestere, l'apparecchio è completo di sorgenti LED ad alta efficienza a tecnologia Chip On Board con riflettore, schermo di protezione trasparente e dissipatore in alluminio. L'apparecchio è fornito di driver. Il grado di protezione contro la penetrazione di polvere, corpi solidi e liquidi è IP40.

Tov is a sober and singular spotlight for ceiling/wall or tracks and it can be adjusted 350° horizontally and 180° vertically. It is made from epoxy polyester powder coated aluminium and it has a metallic reflector and a transparent screen. It is equipped with a Chip On Board technology high efficiency LED light source and driver. Its degree of protection against the penetration of dust, solid objects and liquids is IP40.

-  40° (a richiesta 20°)
(20° on request)
-  TC 3000K / 4000K
-  IP 40
-  CRI 93 (a richiesta >80)
(>80 on request)
-  EEI A+
-  RG 1
-  02 Nero opaco
-  08 Bianco satinato
-  A AN001.08 Anello bianco / White ring
AN001.13 Anello oro / Gold ring



Abitazione privata, Varese



MUR

PROIETTORI / SPOTLIGHTS

Caratterizzato da una forma compatta e minimal, Mur è un proiettore orientabile sui due assi di 180° e 350° che può essere applicato sia a parete/plafone sia a binario elettrificato trifase. Realizzato in alluminio e acciaio verniciato a polvere epossipoliestere, è completo di sorgente LED ad alta efficienza e nella versione da 230V non necessita di driver. Il grado di protezione contro la penetrazione di polvere, corpi solidi e liquidi è IP40.

Characterized by a compact and minimal shape, Mur is a spotlight for ceiling/wall or three circuit track and it can be adjusted 350° horizontally and 180° vertically. It is made from epoxy polyester powder coated aluminium and steel and it is complete with a high efficiency LED light source. The 230V version does not require a driver. Its degree of protection against the penetration of dust, solid objects and liquids is IP40.

-  (vedi tabella) / (see table)
-  TC 3000K / 4000K
-  IP 40
-  CRI 93 — (a richiesta >80) / (>80 on request)
-  EEI A+ (8W-15W) / A++ (10W-17W-23W)
-  RG 1
-  08/02 Bianco satinato/Nero opaco
-  02 Nero opaco
-  08 Bianco satinato

MUR Ø60 230V

CODICE	W	Lm (3000K)	
A2-607.08AC...	8	704	30°

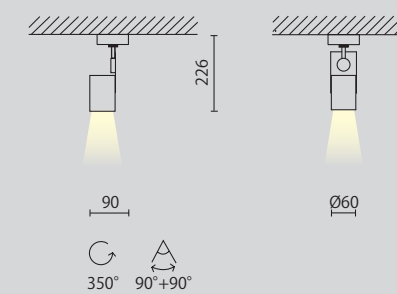

MUR Ø60 DA BINARIO

CODICE	W	Lm (3000K)	
A2-207.../D	10	1320	30°

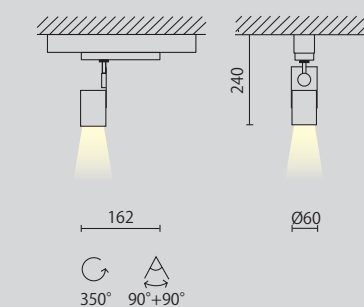



MUR Ø120 230V

CODICE	W	Lm (3000K)	
A2-606.15...	15	1350	40° (a richiesta 24°) (24° on request)

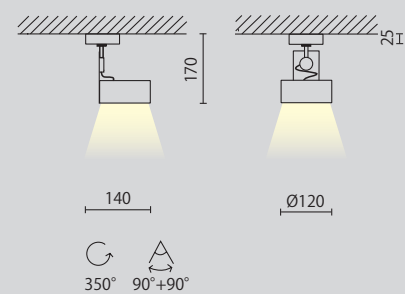

MUR Ø120 DA BINARIO

CODICE	W	Lm (3000K)	
A2-606.17.../D	17	2240	40° (a richiesta 24°) (24° on request)
A2-606.23.../D	23	3025	40° (a richiesta 24°) (24° on request)

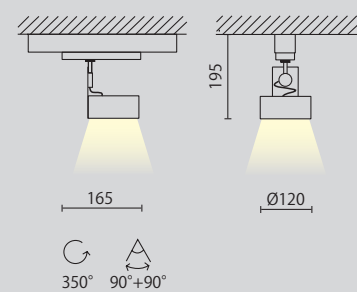



MUR Ø60 230V DA BINARIO

CODICE	W	Lm (3000K)	
A2-607.08AC.../D	8	704	30°

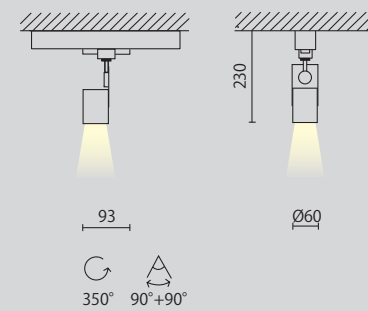

MUR Ø120 230V DA BINARIO

CODICE	W	Lm (3000K)	
A2-606.15.../D	15	1350	40° <small>(a richiesta 24°) (24° on request)</small>

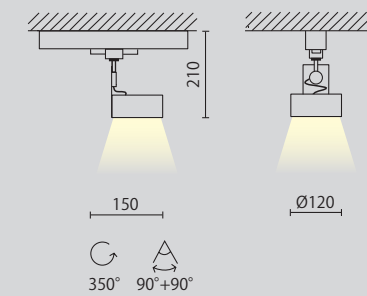



Farmacia, design Andrea Zanini_studio AZdesign

ARCO

Arch. Andrea Zanini_studio AZdesign

PROIETTORI / SPOTLIGHTS

Una forma levigata troncata nettamente in corrispondenza della fonte luminosa distingue Arco, proiettore orientabile che può essere applicato a parete/plafone, a binario elettrificato trifase o ad incasso. Realizzato in alluminio pressofuso, è completo di sorgente LED ad alta efficienza con tecnologia Chip On Board. Le versioni da 230V non necessitano di driver. Il diffusore è in vetro trasparente. Il grado di protezione contro la penetrazione di polvere, corpi solidi e liquidi è IP40.

Arco is a smooth shaped adjustable spotlight for wall/ceiling, three circuit track or recess. This product is made from die-cast aluminium and it is complete with a transparent diffuser, a Chip On Board technology high efficiency LED light source. The 230V versions do not require the driver. Its degree of protection against the penetration of dust, solid objects and liquids is IP40.



ARCO 230V DA BINARIO

CODICE	W	Lm (3000K)
A2-629.20AC.../D	20	1800
A2-629.30AC.../D	30	2700

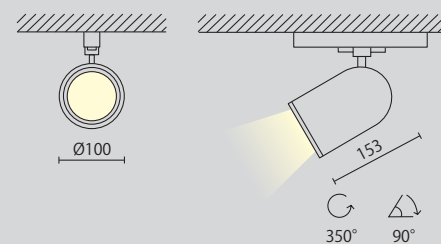

ARCO 230V



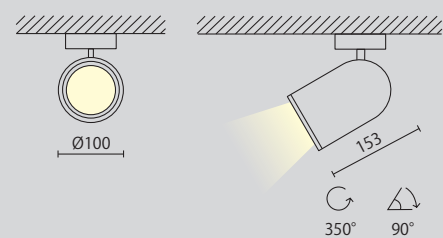



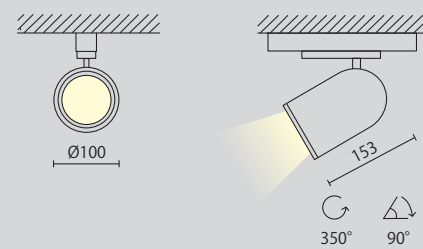

CODICE	W	Lm (3000K)
A2-629.20AC...	20	1800
A2-629.30AC...	30	2700



ARCO DA BINARIO

CODICE	W	Lm (3000K)
A2-628.17.../D	17	2240
A2-628.23.../D	23	2870



-  36° (a richiesta 15° e 24°)
(15° and 24° on request)
-  TC 3000K / 4000K
-  IP 40
-  CRI 93 — (a richiesta >80)
(>80 on request)
-  EEI A+
-  RG 1
-  02 Nero opaco
-  08 Bianco satinato

ARCO INCASSO

CODICE	W	Lm (3000K)
A5-628.17...	17	2240
A5-628.24...	24	3025

/DIMM2 dimmerabile protocollo DALI
/DIMM3 dimmerabile switch-DIM

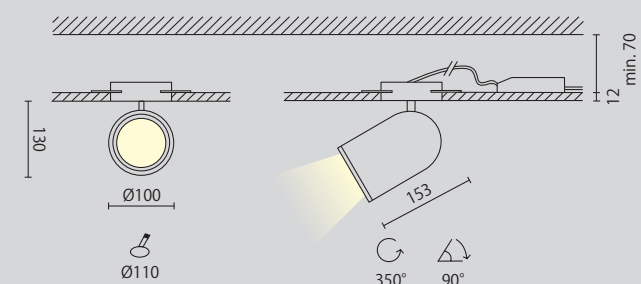

Farmacia, design Andrea Zanini_studio AZdesign





ZETA

PROIETTORI / SPOTLIGHTS

Proiettore orientabile dall'innovativo braccio di supporto, che contiene al suo interno il driver, Zeta viene applicato su binario elettrificato trifase. Realizzato in alluminio pressofuso, è completo di sorgente LED ad alta efficienza con tecnologia Chip On Board. Il diffusore è in vetro trasparente. Il grado di protezione contro la penetrazione di polvere, corpi solidi e liquidi è IP40.

Zeta is an adjustable spotlight for three circuit track characterized by an innovative bracket, which hosts the driver. This product is made from die-cast aluminium and it is complete with a transparent diffuser and a Chip On Board technology high efficiency LED light source. Its degree of protection against the penetration of dust, solid objects and liquids is IP40.



COSMETICS base Sky and smooth feel gel which is made by dispersing of swelable sponge-like spheres in a mixture of silicones.

COSMETICS lips Sponge-like spheres absorb the excess fluid of as much as available to reach a saturation equilibrium.

COSMETICS EYES Sponge-like spheres create a very strong matifying effect by scattering the incoming rays of light in all directions and diminish the reflected light.

ZETA 85

CODICE	W	Lm (3000K)
A2-640.18...	18	2240

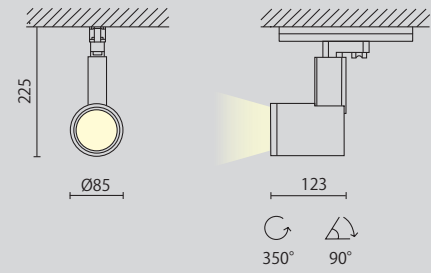

ZETA 110

CODICE	W	Lm (3000K)
A2-642.30AC...	30	2700
A2-642.25...	25	3020
A2-642.34...	34	3860
A2-642.38...	38	4425

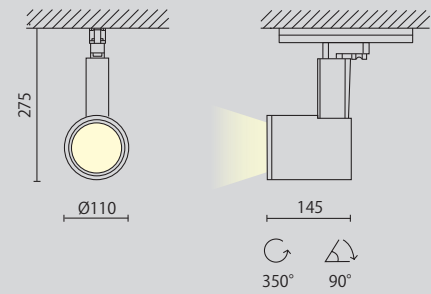

ZETA 130

CODICE	W	Lm (3000K)
A2-644.40AC...	40	3600
A2-644.38...	38	4425
A2-644.44...	44	4975
A2-644.46...	46	5790

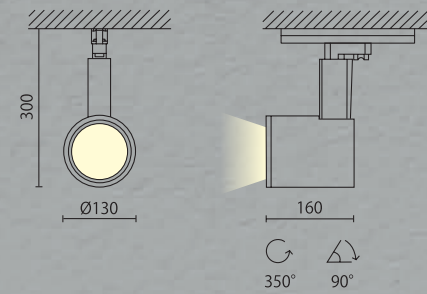

	36° (a richiesta 15° e 24°) (15° and 24° on request)
TC	3000K / 4000K
IP	40
CRI	93 (a richiesta >80) (>80 on request)
EEL	>80 versione AC / AC version
EEL	A++ / A+ (30W-40W)
RG	1
02	Nero opaco
08	Bianco satinato



HARRY

CODICE	W	Lm (3000K)
A2-608.17...	17	2240

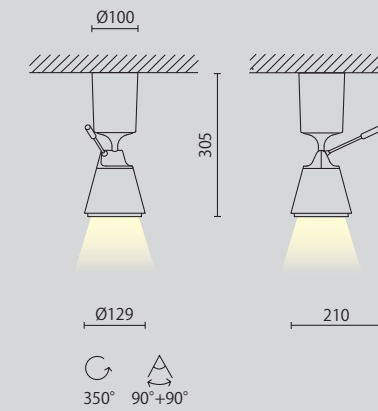

HARRY DA BINARIO

CODICE	W	Lm (3000K)
A2-608.17.../D	17	2240

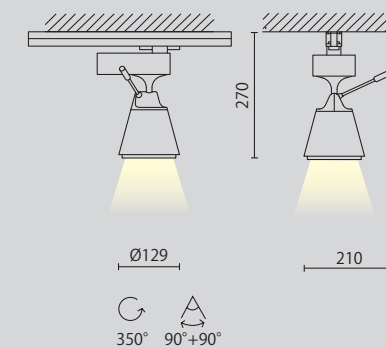









HARRY

PROIETTORI / SPOTLIGHTS

Reso brioso dalla forma conica e dalla particolare impugnatura, che ne permette la rotazione sui due assi di 350° e 180°, Harry è un proiettore da parete/plafone o da binario elettrificato. Realizzato in alluminio pressofuso verniciato a polvere epossipoliestere, viene fornito completo di sorgente LED ad alta efficienza a tecnologia Chip On Board. La versione da 230V non necessita di driver. Il grado di protezione contro la penetrazione di polvere, corpi solidi e liquidi è IP40.

The conic shape and the unique handgrip, which allows it to be rotated on both axes, give Harry a sprightly look. This luminaire for ceiling/wall or tracks is made from epoxy polyester powder coated aluminium and it is complete with a Chip On Board technology high efficiency LED light source. The 230V version does not require the driver. Its degree of protection against the penetration of dust, solid objects and liquids is IP40.

-  40° (a richiesta 24°)
(24° on request)
-  3000K / 4000K
-  40
-  93 (a richiesta >80)
(>80 on request)
-  A++ / A+ (15W)
-  1
-  02 Nero opaco
-  08 Bianco satinato



HARRY 230V DA BINARIO

CODICE	W	Lm (3000K)
A2-604.15AC.../D	15	1350

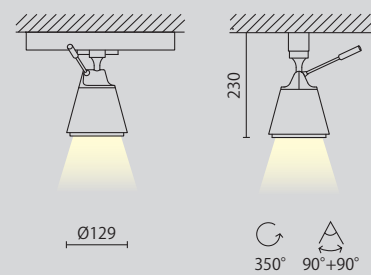

CODICE	DESCRIZIONE / DESCRIPTION
6901	Binario lunghezza m 1. Colore: 01 - 02 - 20 Track, 1m long. Colours: 01 - 02 - 20
6902	Binario lunghezza m 2. Colore: 01 - 02 - 20 Track, 2m long. Colours: 01 - 02 - 20
6903	Binario lunghezza m 3. Colore: 01 - 02 - 20 Track, 3m long. Colours: 01 - 02 - 20
6904	Alimentazione a destra. Colore: 01 - 02 - 20 Right feed connector. Colours: 01 - 02 - 20
6905	Alimentazione a sinistra. Colore: 01 - 02 - 20 Left feed connector. Colours: 01 - 02 - 20
6906	Giunto lineare. Colore: 01 - 02 In-line connector. Colours: 01 - 02
6907	Giunto lineare senza contatti. Colore: 01 - 02 In-line connector, mechanical only. Colours: 01 - 02
6908	Giunto flessibile. Colore: 01 - 02 - 20 Flexible connector. Colours: 01 - 02 - 20
6909	Giunto L interno. Colore: 01 - 02 - 20 Internal connector. Colours: 01 - 02 - 20
6910	Giunto L esterno. Colore: 01 - 02 - 20 External connector. Colours: 01 - 02 - 20
6911	Giunto T destro. Colore: 01 - 02 - 20 T connector right hand. Colours: 01 - 02 - 20
6912	Giunto T sinistro. Colore: 01 - 02 - 20 T connector left hand. Colours: 01 - 02 - 20
6913	Giunto X. Colore: 01 - 02 - 20 X connector. Colours: 01 - 02 - 20
6914	Alimentazione centrale o giunto lineare. Colore: 01 - 02 - 20 Central feed connector or central connector. Colours: 01 - 02 - 20
6915	Tappo per fine binario. Colore: 01 - 02 - 20 End cap. Colours: 01 - 02 - 20
6916	Coperchio per binario cm 100. Colore: 01 - 02 Track cover plate, cm 100. Colours: 01 - 02
6917	Sospensione di cm 200 con rosone. Colore: 01 - 02 Cable suspension kit with ceiling cup, cm 200. Colours: 01 - 02
6918	Supporto a soffitto. Ceiling clips.



- 01 Bianco
- 02 Nero
- 20 Anodizzato naturale

DUE

BINARIO / TRACKS

Rispettare la continuità del neutro.

Porre particolare attenzione nella scelta dei giunti necessari alla composizione, tutti disponibili in versione destra e sinistra, avendo cura di rispettare la stessa posizione della linea neutra collocata lateralmente sul giunto evidenziata nel disegno con il colore BLU.

Respect the continuity of the neutral.

Pay particular attention when choosing the joints required for assembly, all available in left and right versions, making sure to place them in the same position as the neutral line placed laterally on the joints highlighted in BLUE on the diagram.

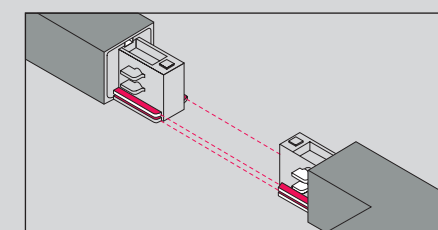
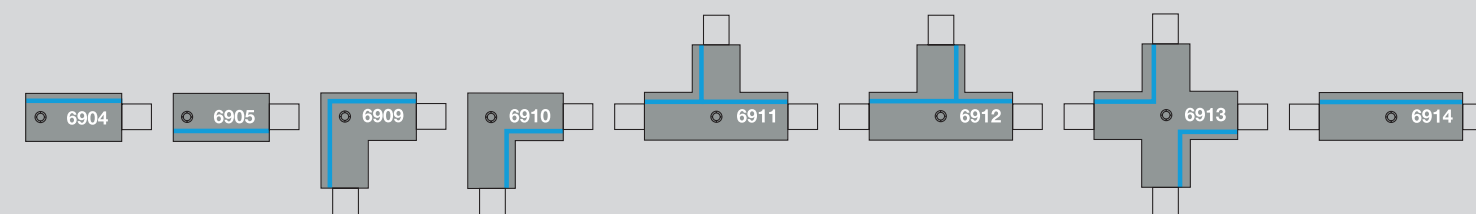

Un'ulteriore prova che si può fare dal punto di vista visivo, atta a capire se la scelta dei giunti utilizzati nella composizione è quella corretta, consiste nel mantenere direzionate nello stesso senso, e per tutta la lunghezza della composizione, le due guide laterali in plastica e quella singola presente sul lato opposto del giunto.

A further visual test that can be carried out in order to check whether the choice of the joint used in the assembly is the right one is to keep the two plastic side runners and the single runner on the other side of the joint facing the same direction all along the track.

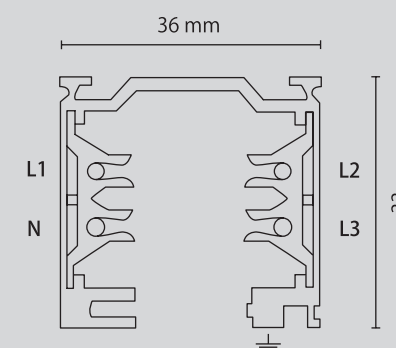

BINARI STANDARD (ON/OFF) / STANDARD TRACKS (ON/OFF) Schema di collegamento / Connection scheme

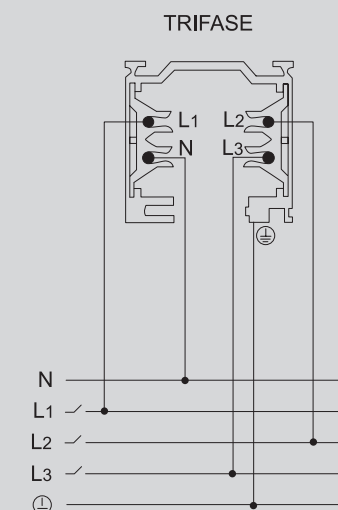



INCASSI
RECESSED

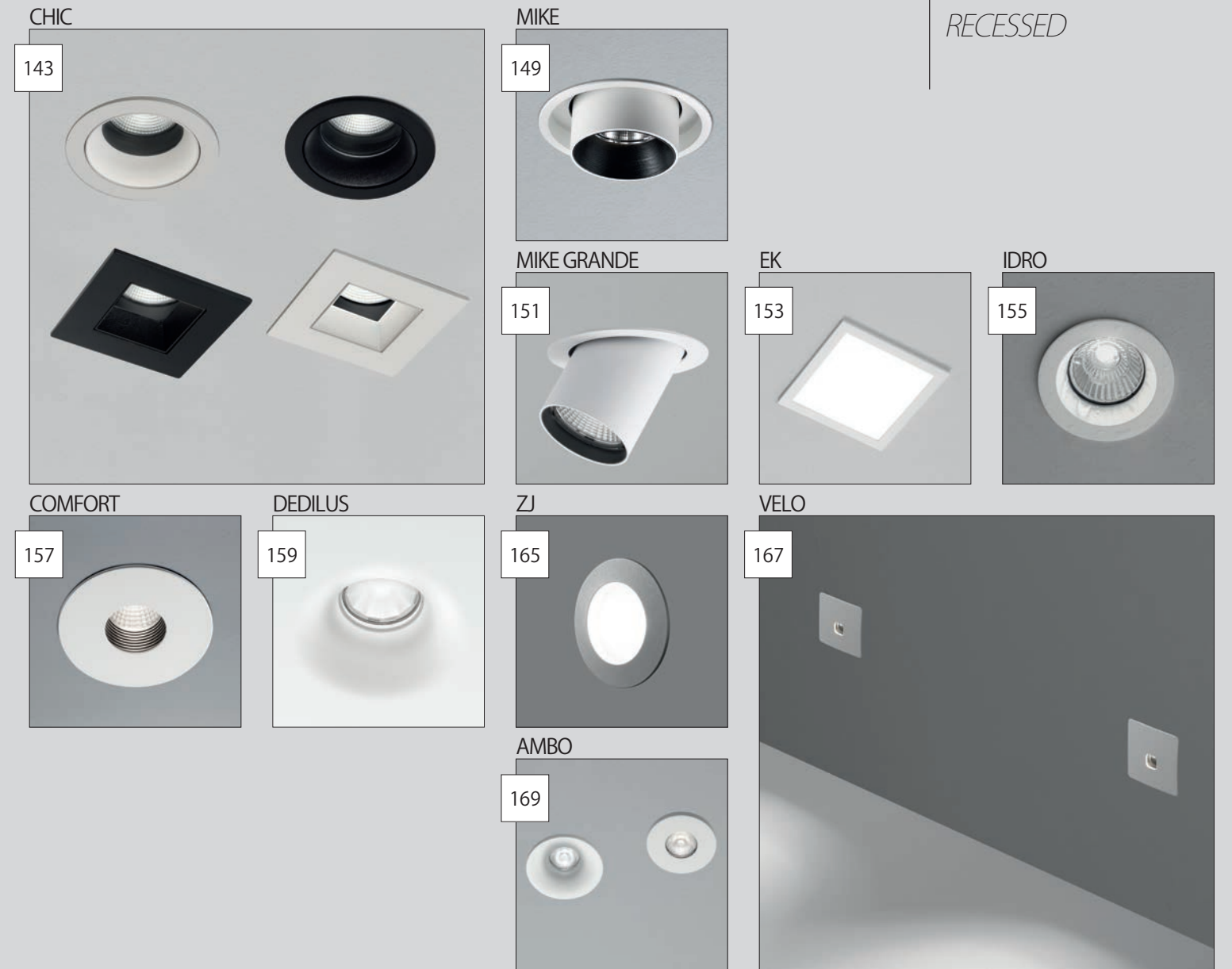
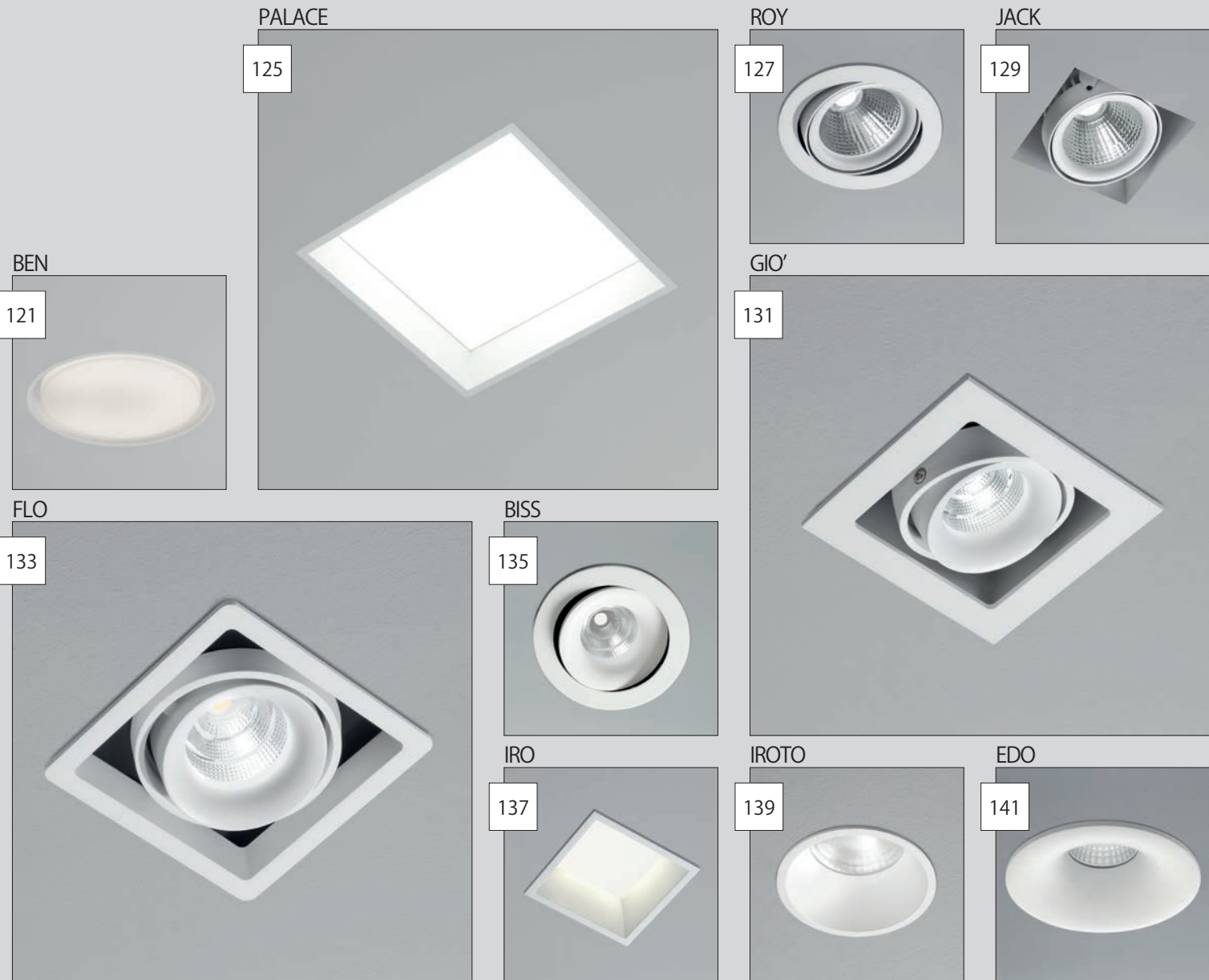



	120°
TC	3000K / 4000K
IP	40
CRI	>80
EEL	A++
RG	0
08	Bianco satinato Driver incluso Driver included
D	Driver incluso Driver included

BEN

INCASSI / RECESSED

Volume di luce che sembra emergere dal soffitto, Ben è un apparecchio ad incasso realizzato in alluminio verniciato a polvere epossipoliestere stabilizzata ai raggi UV con diffusore in polietilene satinato. Disponibile con o senza bordo e in due differenti misure, è equipaggiato con LED ad alta efficienza a tecnologia Chip On Board e driver. Il grado di protezione contro la penetrazione di polvere, corpi solidi e liquidi è IP40.

Ben is a recessed light which seems to emerge from the ceiling surface. It is made from epoxy polyester powder coated aluminium stabilized with UV rays and it has a frosted polyethylene diffuser. Equipped with a Chip On Board technology high efficiency LED light source and driver, Ben is available in two sizes and in the trim or trimless version. Its degree of protection against the penetration of dust, solid objects and liquids is IP40.

BEN Ø 413 CON BORDO / WITH TRIM

CODICE	W	Lm (3000K)
A5-692...	25	3610

/DIMM2 dimmerabile protocollo DALI
/DIMM3 dimmerabile switch-DIM
/EM modulo in emergenza

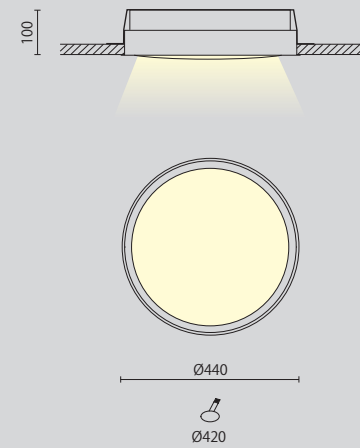

BEN Ø 413 SENZA BORDO / TRIMLESS

CODICE	W	Lm (3000K)
A5-672...	25	3610

/DIMM2 dimmerabile protocollo DALI
/DIMM3 dimmerabile switch-DIM
/EM modulo in emergenza

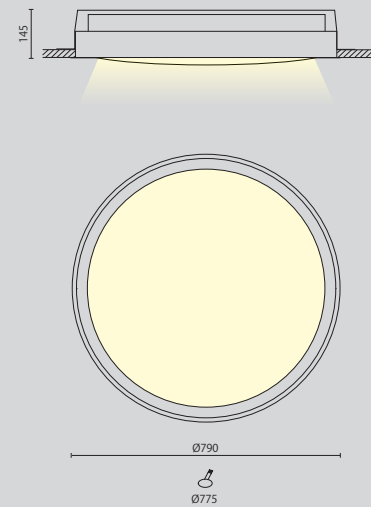
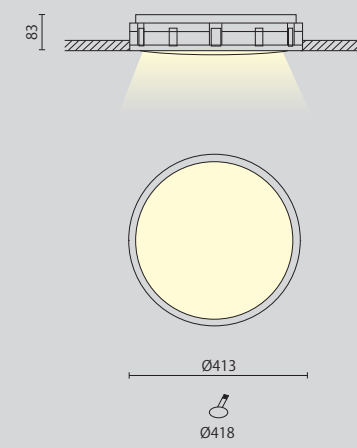

BEN Ø 764 CON BORDO / WITH TRIM

CODICE	W	Lm (3000K)
A5-693.70...	70	8800

/DIMM2 dimmerabile protocollo DALI
/DIMM3 dimmerabile switch-DIM
/EM modulo in emergenza

BEN Ø 764 SENZA BORDO / TRIMLESS

CODICE	W	Lm (3000K)
A5-673.70...	70	8800

/DIMM2 dimmerabile protocollo DALI
/DIMM3 dimmerabile switch-DIM
/EM modulo in emergenza

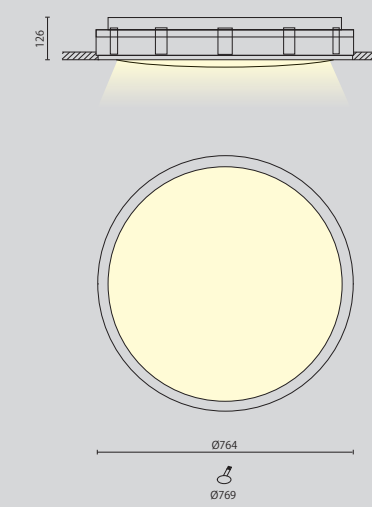



PALACE PRO SENZA BORDO / TRIMLESS

CODICE	W	Lm (3000K)
A5-620.026...	25	3530

/DIMM2 dimmerabile protocollo DALI
/DIMM3 dimmerabile switch-DIM
/EM modulo in emergenza

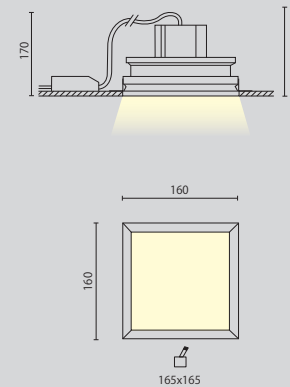

PALACE PRO CON BORDO / WITH TRIM

CODICE	W	Lm (3000K)
A5-621.026...	25	3530

/DIMM2 dimmerabile protocollo DALI
/DIMM3 dimmerabile switch-DIM
/EM modulo in emergenza

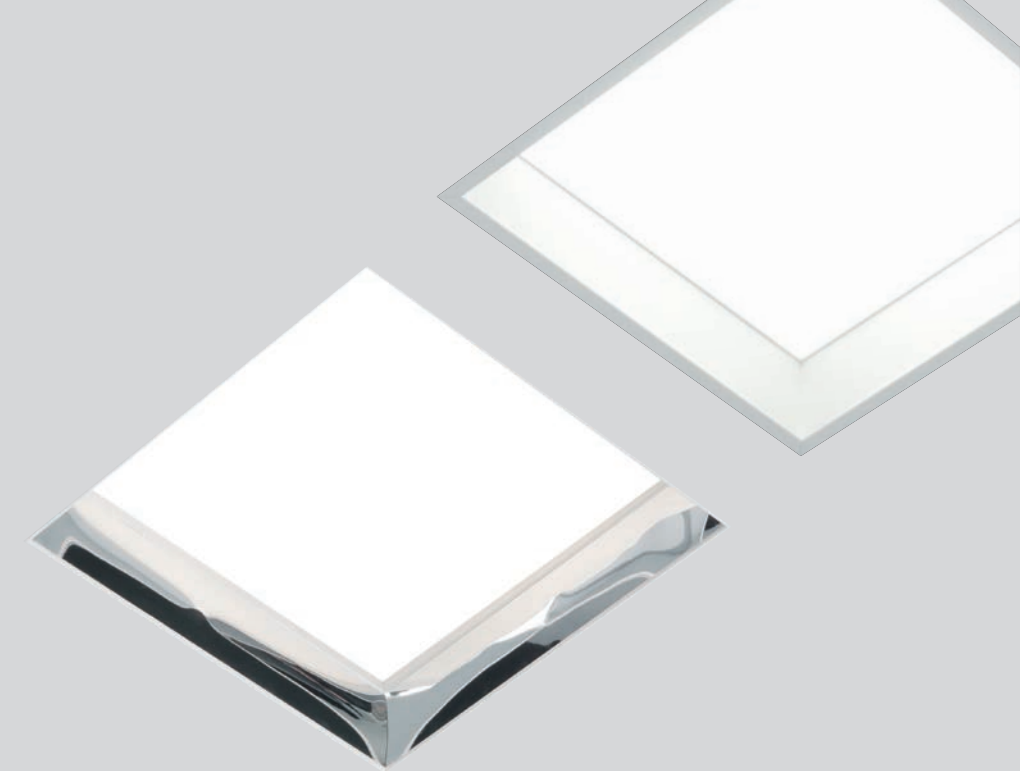
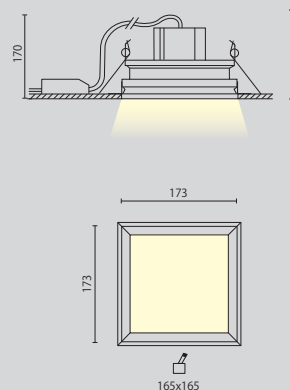

PALACE

INCASSI / RECESSED

Contraddistinto da una linea squadrata e pura, Palace è un apparecchio perfetto per illuminare con luce diffusa gli spazi che richiedono pulizia formale. Il dispositivo è disponibile con o senza bordo, è realizzato in acciaio ed alluminio estruso verniciato a polvere epossipoliestere con schermo in policarbonato opale ed è equipaggiato con LED ad alta efficienza a tecnologia Chip On Board e driver remoto. Richiedibile anche nelle versioni emergenza tipo SA, autonomia 1h, e dimmerabile DALI/switch-dim. Il grado di protezione contro la penetrazione di polvere, corpi solidi e liquidi è IP43.

Identified by a squared and pure line, Palace is the perfect lamp to enlighten every space with diffuse light. It is made from epoxy polyester powder coated aluminium and it has an opal polycarbonate screen. Equipped with a Chip On Board technology high efficiency LED light source and a remote driver, this luminaire is available both with trim and trimless. The lamp can be requested in the SA emergency version (1 hour of autonomy) and in the DALI dimmable version. Its degree of protection against the penetration of dust, solid objects and liquids is IP43.

	100°
TC	3000K / 4000K
IP	43
CRI	>80
EEL	A++
RG	0
08	Bianco satinato
08 / 14	Bianco satinato/Cromato
14	Cromato (A5-620.026)
D	Driver incluso Driver included



CODICE	W	Lm (3000K)
A5-662.22...	17	2240
A5-662.28...	25	3025
A5-662.33...	33	3755

/DIMM2 dimmerabile protocollo DALI
/DIMM3 dimmerabile switch-DIM

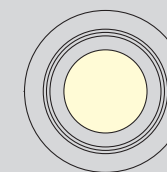
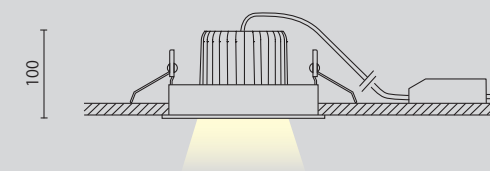

Ø170
Ø160 45°+45° 355°

	42° (a richiesta 20°) (20° on request)
TC	3000K / 4000K
IP	23
CRI	93 (a richiesta >80) (>80 on request)
EEL	A++
RG	1
08	Bianco satinato
D	Driver incluso Driver included

ROY

INCASSI / RECESSED

La discrezione di un corpo ad incasso e la comodità di un apparecchio orientabile. Roy è realizzato in alluminio pressofuso ed è equipaggiato con sorgente LED ad alta efficienza con tecnologia Chip On Board. Driver remoto incluso. Il grado di protezione contro la penetrazione di polvere, corpi solidi e liquidi è IP23.

Roy is a discreet adjustable recessed light. It is made from die-cast aluminium and it is equipped with a Chip On Board technology high efficiency LED light source and a remote driver. Its degree of protection against the penetration of dust, solid objects and liquids is IP23.



JACK

INCASSI / RECESSED

Il quadrato ed il cerchio, due forme semplici e perfette, accostate per dare carattere a Jack, un apparecchio ad incasso orientabile, disponibile con o senza bordo, realizzato in alluminio pressofuso e acciaio ed equipaggiato con LED ad alta efficienza a tecnologia Chip On Board. Driver remoto incluso. Il grado di protezione contro la penetrazione di polvere, corpi solidi e liquidi è IP23.

The perfection and simplicity of a circle and of a square matched to give Jack personality. This adjustable recessed light is made from die-cast aluminium and steel and it is equipped with a Chip On Board technology high efficiency LED light source and a remote driver. Its degree of protection against the penetration of dust, solid objects and liquids is IP23.

JACK

CODICE	W	Lm
A5-663.22.30	22	2500
A5-663.28.30	28	3100
A5-663.33.30	33	3550

/DIMM2 dimmerabile protocollo DALI
/DIMM3 dimmerabile switch-DIM

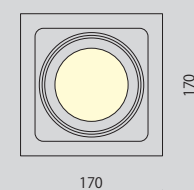
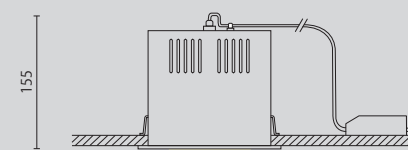

152x152 30°+30° 355°







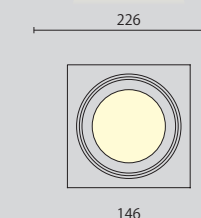
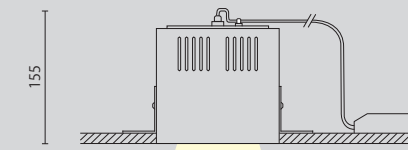

JACK HIDE

CODICE	W	Lm
A5-664.22.30	22	2500
A5-664.28.30	28	3100
A5-664.33.30	33	3550

/DIMM2 dimmerabile protocollo DALI
/DIMM3 dimmerabile switch-DIM



150x150 30°+30° 355°

-  42° (a richiesta 20°)
(20° on request)
-  TC 3000K
-  IP 23
-  CRI >80
-  EEI A+
-  RG 1
-  08 Bianco satinato
-  D Driver incluso
Driver included



GIO'

INCASSI / RECESSED

Essenziale nelle geometrie, Giò è un apparecchio ad incasso orientabile disponibile con o senza bordo. Realizzato in alluminio pressofuso, è equipaggiato con sorgente LED ad alta efficienza con tecnologia Chip On Board e driver remoto incluso. Il grado di protezione contro la penetrazione di polvere, corpi solidi e liquidi è IP43.

Geometric essentiality characterizes Gio', an adjustable recessed light made from die-cast aluminium and equipped with a Chip On Board technology high efficiency LED light source and a remote driver. This lamp is available both trim and trimless. Its degree of protection against the penetration of dust, solid objects and liquids is IP43.

GIO'

CODICE	W	Lm
A5-665.07.30	7	670
A5-665.10.30	10	900

/DIMM2 dimmerabile protocollo DALI
/DIMM3 dimmerabile switch-DIM

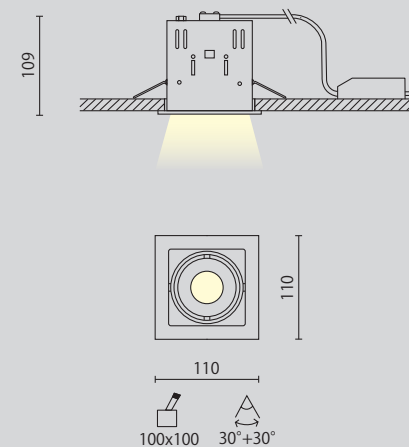







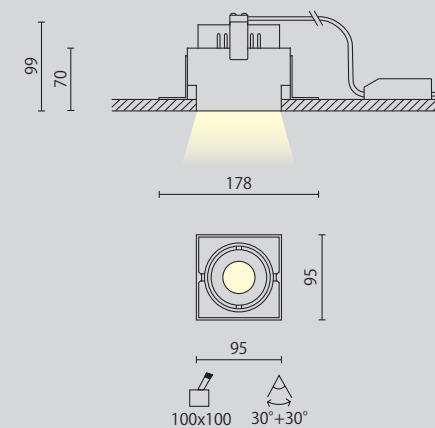

GIO' HIDE

CODICE	W	Lm
A5-666.07.30	7	670
A5-666.10.30	10	900

/DIMM2 dimmerabile protocollo DALI
/DIMM3 dimmerabile switch-DIM









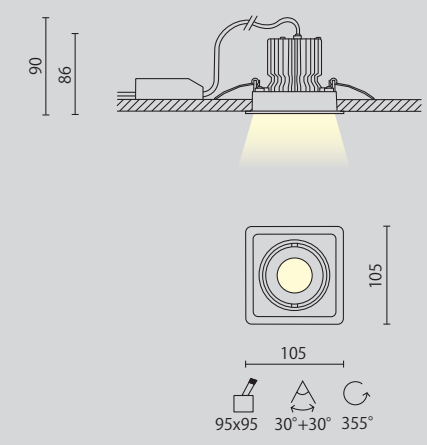

-  36°
-  TC 3000K
-  IP 43
-  CRI >80
-  EEI A+
-  RG 1
-  08 Bianco satinato
-  D Driver incluso
Driver included



CODICE	W	Lm
A5-670.07.30	7	670
A5-670.10.30	10	900

/DIMM2 dimmerabile protocollo DALI
 /DIMM3 dimmerabile switch-DIM



-  36°
-  TC 3000K
-  IP 43
-  CRI >80
-  EEI A+
-  RG 1
-  08 Bianco satinato
-  D Driver incluso
Driver included

FLO

INCASSI / RECESSED

Linee dolci e smussate, Flo è un apparecchio ad incasso orientabile realizzato in alluminio pressofuso, equipaggiato con sorgente LED ad alta efficienza con tecnologia Chip On Board. Driver remoto incluso. Il grado di protezione contro la penetrazione di polvere, corpi solidi e liquidi è IP43.

Flo is an adjustable recessed light identified by smooth and soft lines. It is made from die-cast aluminium and equipped with a Chip On Board technology high efficiency LED light source and a remote driver. Its degree of protection against the penetration of dust, solid objects and liquids is IP43.



CODICE	W	Lm
A5-680.07.30	7	560
A5-680.12.30	10	740
A5-680.15.30	15	920

/DIMM2 dimmerabile protocollo DALI
/DIMM3 dimmerabile switch-DIM

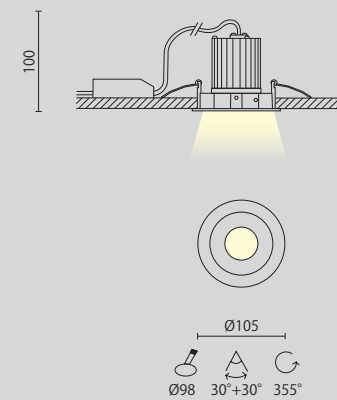









BISS

INCASSI / RECESSED



Elemento di forma perfetta e presenza discreta, Biss è un apparecchio ad incasso orientabile realizzato in alluminio pressofuso, equipaggiato con sorgente LED ad alta efficienza con tecnologia Chip On Board. Driver remoto incluso. Il grado di protezione contro la penetrazione di polvere, corpi solidi e liquidi è IP23.

Biss is an adjustable recessed light characterized by a perfect and unobtrusive design. It is made from die-cast aluminium and equipped with a Chip On Board technology high efficiency LED light source and a remote driver. Its degree of protection against the penetration of dust, solid objects and liquids is IP23.

-  44° (a richiesta 22°)
(22° on request)
-  TC 3000K
-  IP 23
-  CRI 93
-  EEI A+
-  RG 1
-  08 Bianco satinato
-  D Driver incluso
Driver included



IRO PICCOLO

CODICE	W	Lm	
A5-668.11.30	11	950	85°

/DIMM2 dimmerabile protocollo DALI
/DIMM3 dimmerabile switch-DIM

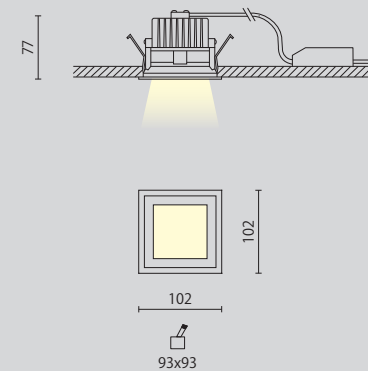

IRO

INCASSI / RECESSED

Fine ed elegante nella sua essenzialità, Iro è un apparecchio ad incasso realizzato in alluminio pressofuso, con diffusore satinato, equipaggiato con sorgente LED ad alta efficienza e driver remoto. È disponibile in due misure. Il grado di protezione contro la penetrazione di polvere, corpi solidi e liquidi è IP43.

Refined and elegant, Iro is a recessed light made from die-cast aluminium and equipped with a frosted diffuser, a Chip On Board technology high efficiency LED light source and a remote driver. It is available in two sizes. Its degree of protection against the penetration of dust, solid objects and liquids is IP43.

	(vedi tabella) / (see table)
TC	3000K
IP	43
CRI	>80
EEL	A+
RG	0
08	Bianco satinato
D	Driver incluso Driver included

IRO GRANDE

CODICE	W	Lm	
A5-669.25.30	25	2200	95°

/DIMM2 dimmerabile protocollo DALI
/DIMM3 dimmerabile switch-DIM

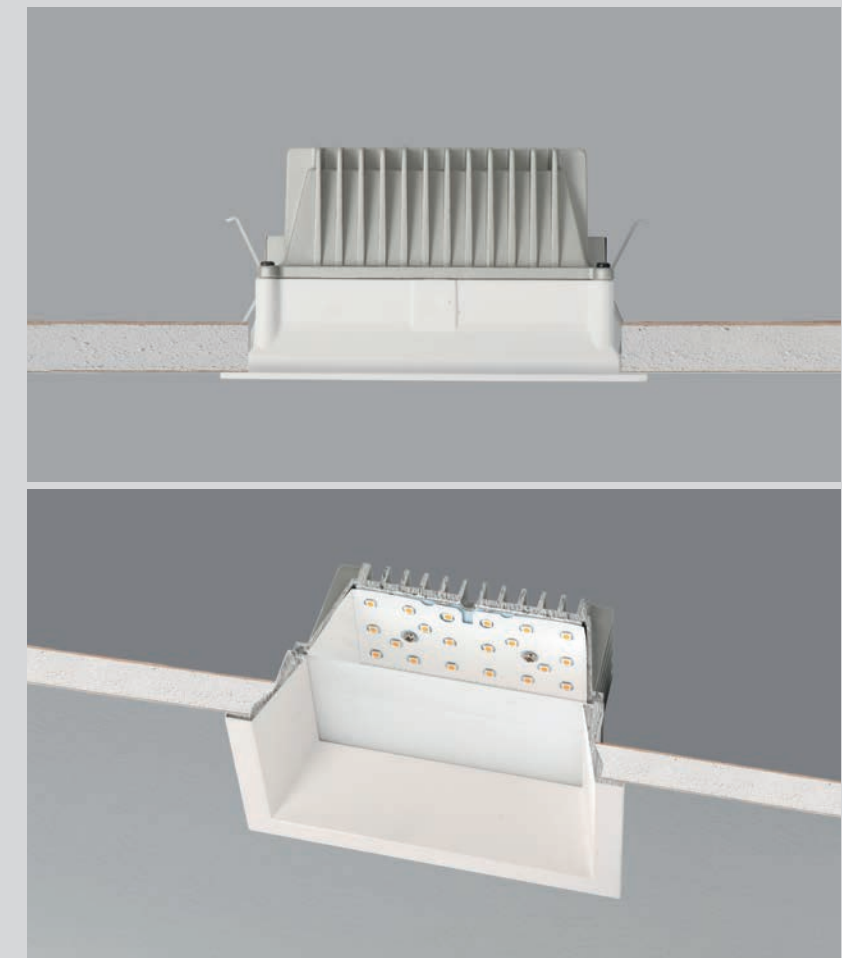
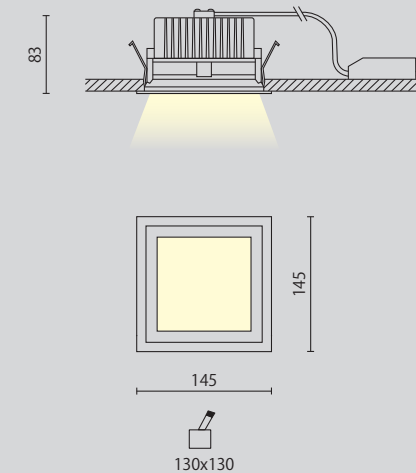



CODICE	W	Lm
A5-629.10.30	10	865

/DIMM2 dimmerabile protocollo DALI
/DIMM3 dimmerabile switch-DIM

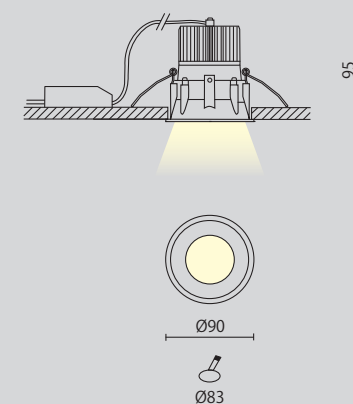

	45° (a richiesta 35°) (35° on request)
TC	3000K
IP	43
CRI	93
EEL	A+
RG	0
08	Bianco satinato Driver incluso Driver included
D	

IROTO

INCASSI / RECESSED



Aspetto puro e semplice, Iroto è un apparecchio ad incasso realizzato in alluminio, con diffusore satinato, equipaggiato con sorgente LED ad alta efficienza e driver remoto. Il grado di protezione contro la penetrazione di polvere, corpi solidi e liquidi è IP43.

A pure and basic design identifies Iroto, a recessed light made from aluminium. Complete with a frosted diffuser, it is equipped with a high efficiency LED light source and a remote driver. Its degree of protection against the penetration of dust, solid objects and liquids is IP43.



EDO GRANDE

CODICE	W	Lm
A5-676.15.30	15	1513

/DIMM2 dimmerabile protocollo DALI
/DIMM3 dimmerabile switch-DIM

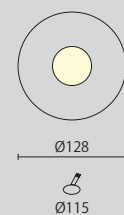
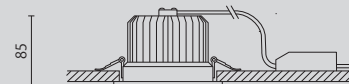

EDO PICCOLO

CODICE	W	Lm
A5-675.10.30	7	900

/DIMM2 dimmerabile protocollo DALI
/DIMM3 dimmerabile switch-DIM

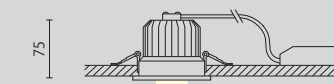

EDO

INCASSI / RECESSED



Caratterizzato da una forma morbida, Edo è un apparecchio ad incasso realizzato in alluminio pressofuso ed equipaggiato con sorgente LED ad alta efficienza con tecnologia Chip On Board. Disponibile in due misure, viene fornito con driver remoto incluso. Il grado di protezione contro la penetrazione di polvere, corpi solidi e liquidi è IP44.

A curvy shape identifies Edo, a recessed light made from die-cast aluminium and equipped with a Chip On Board technology high efficiency LED light source and a remote driver. It is available in two sizes. Its degree of protection against the penetration of dust, solid objects and liquids is IP44.

	40°
TC	3000K
IP	44
CRI	93
EEL	A+
RG	1
08	Bianco satinato
D	Driver incluso Driver included



CHIC TONDO

CODICE	W	Lm (3000K)	
A5-605.07...	7	560	50°
A5-605.10...	10	740	50°

/DIMM2 dimmerabile protocollo DALI

/DIMM3 dimmerabile switch-DIM

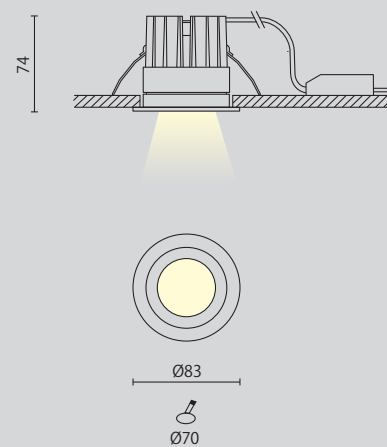

CHIC

INCASSI / RECESSED

Tre colori, bianco, nero e oro, vestono raffinemente Chic, apparecchio da incasso disponibile in versione Tondo e Quadro. Realizzato in alluminio con diffusore trasparente, è equipaggiato con sorgente LED ad alta efficienza e driver remoto. Il grado di protezione contro la penetrazione di polvere, corpi solidi e liquidi è IP44.

White, black and gold dandify Chic, a recessed aluminium light available in two different shapes, Tondo and Quadro. Complete with a clear diffuser, it is equipped with a high efficiency LED light source and a remote driver. Its degree of protection against the penetration of dust, solid objects and liquids is IP44.

	(vedi tabella) / (see table)
TC	3000K / 4000K
IP	44
CRI	93
EEI	A+
RG	1
02	Nero opaco
02 / 13	Nero opaco/Oro
08	Bianco satinato
08 / 02	Bianco satinato/Nero opaco
D	Driver incluso Driver included





CHIC QUADRO

CODICE	W	Lm (3000K)	
A5-606.07...	7	560	40°
A5-606.10...	10	740	40°

/DIMM2 dimmerabile protocollo DALI
 /DIMM3 dimmerabile switch-DIM

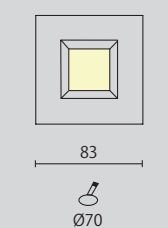
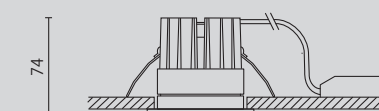

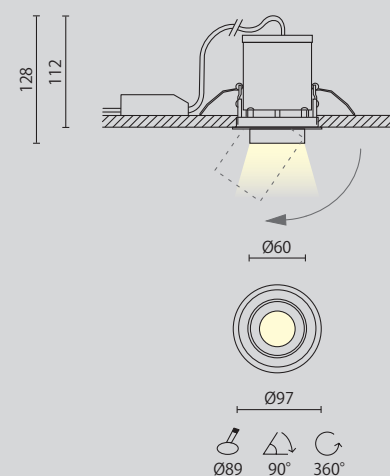







MIKE

INCASSI / RECESSED

CODICE	W	Lm (3000K)
A5-678.07...	7	900
A5-678.10...	10	1240

/DIMM2 dimmerabile protocollo DALI
/DIMM3 dimmerabile switch-DIM

-  40° (a richiesta 20°)
(20° on request)
-  TC 3000K / 4000K
-  IP 23
-  CRI 93 (a richiesta >80)
(>80 on request)
-  EEI A++
-  RG 1
-  08 Bianco satinato
-  A AN001.08 Anello bianco / White ring
AN001.13 Anello oro / Gold ring
-  D Driver incluso
Driver included

Estremamente versatile grazie all'incasso estraibile ed orientabile, Mike è un apparecchio realizzato in alluminio pressofuso, completo di sorgente LED ad alta efficienza con tecnologia Chip On Board e driver remoto. Su richiesta è possibile cambiare il colore dell'anello interno, normalmente nero, scegliendo tra i colori bianco o oro. Il grado di protezione contro la penetrazione di polvere, corpi solidi e liquidi è IP23.

A recessed light which can be pulled out and adjusted on both axis. Mike is made from die-cast aluminium and it is equipped with a Chip On Board technology high efficiency LED light source and a remote driver. The inner ring can be requested in black, gold or white. Its degree of protection against the penetration of dust, solid objects and liquids is IP23.



MIKE GRANDE

INCASSI / RECESSED

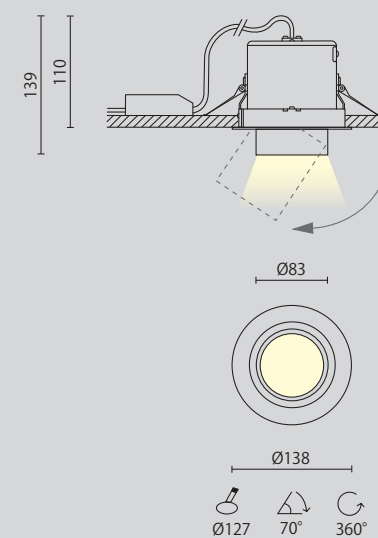

CODICE	W	Lm (3000K)
A5-679.12...	12	1540
A5-679.18...	18	2140

/DIMM2 dimmerabile protocollo DALI
/DIMM3 dimmerabile switch-DIM

-  36° (a richiesta 15° e 50°)
(15° e 50° on request)
-  TC 3000K / 4000K
-  IP 23
-  CRI 93 (a richiesta >80)
(>80 on request)
-  EEI A++
-  RG 1
-  08 Bianco satinato
-  A AN002.08 Anello bianco / White ring
AN002.13 Anello oro / Gold ring
-  D Driver incluso
Driver included

Scenografico senza essere invasivo, Mike Grande è un apparecchio ad incasso estraibile ed orientabile, realizzato in alluminio pressofuso, completo di sorgente LED ad alta efficienza con tecnologia Chip On Board e driver. Su richiesta è possibile cambiare il colore dell'anello interno, normalmente nero, scegliendo tra i colori bianco o oro. Il grado di protezione contro la penetrazione di polvere, corpi solidi e liquidi è IP23.

Mike Grande is a magnificent but discreet recessed light which can be pulled out and adjusted on both axis. It is made from die-cast aluminium and it is equipped with a Chip On Board technology high efficiency LED light source and a remote driver. The inner ring can be requested in black, gold or white. Its degree of protection against the penetration of dust, solid objects and liquids is IP23.

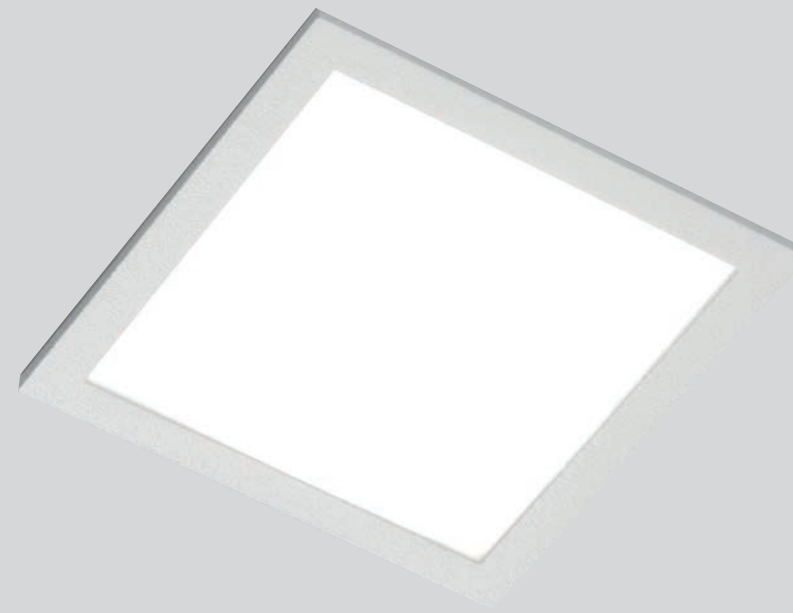









EK

INCASSI / RECESSED

Minimale nella forma, EK è un apparecchio da incasso in acciaio con bordo verniciato a polvere epossidica stabilizzata ai raggi UV. È equipaggiato con LED ad alta efficienza montato su dissipatore in alluminio protetto da diffusore in policarbonato. Non necessita di driver. Il grado di protezione contro la penetrazione di polvere, corpi solidi e liquidi è IP43.

EK is a recessed light characterized by the minimal design. It is made from steel and the trimmer is coated with epoxy powder stabilized with UV rays. This product has a polycarbonate diffuser and it is equipped with a high efficiency LED light source. It does not require a driver. Its degree of protection against the penetration of dust, solid objects and liquids is IP43.

-  95°
-  TC 3000K / 4000K
-  IP 43
-  CRI >80
-  EEI A+
-  RG 0
-  08 Bianco satinato
-  D Driver non richiesto
Driver not requested

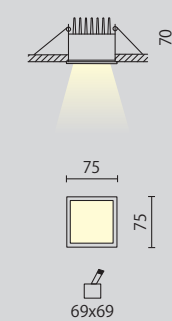

CODICE	W	Lm (3000K)
A5-632.08AC...	8	700



IDRO TONDO

CODICE	W	Lm
A5-681.07.30	7	670
A5-681.10.30	10	900

/DIMM2 dimmerabile protocollo DALI
/DIMM3 dimmerabile switch-DIM

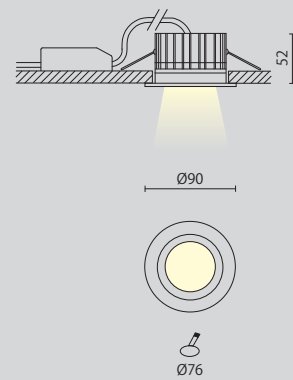

IDRO QUADRO

CODICE	W	Lm
A5-682.07.30	7	670
A5-682.10.30	10	900

/DIMM2 dimmerabile protocollo DALI
/DIMM3 dimmerabile switch-DIM

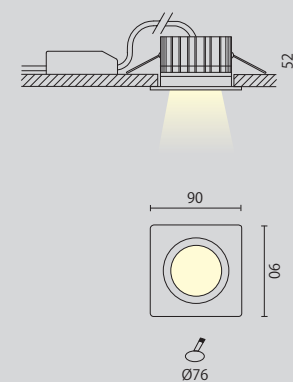

	30°
TC	3000K
IP	55
CRI	>80
EEL	A+
RG	1
08	Bianco satinato
D	Driver incluso Driver included

IDRO

INCASSI / RECESSED

Particolarmente adatto ad essere installato in ambienti in cui è richiesto un elevato grado di protezione da acqua e polvere, Idro è un apparecchio ad incasso fisso realizzato in alluminio pressofuso e disponibile in due versioni, Tondo e Quadro. È equipaggiato con sorgente LED ad alta efficienza con tecnologia Chip On Board e driver remoto. Il grado di protezione contro la penetrazione di polvere, corpi solidi e liquidi è IP55.

Designed to be installed in spaces with high levels of humidity or dust, Idro is a recessed light made from die-cast aluminium. Available in two versions, Tondo and Quadro, it is equipped with a Chip On Board technology high efficiency LED light source and a remote driver. Its degree of protection against the penetration of dust, solid objects and liquids is IP55.





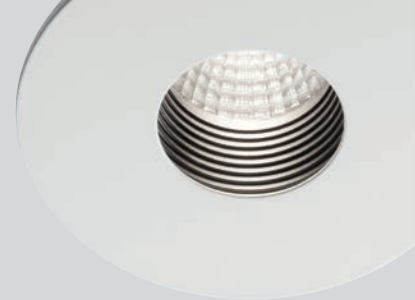



COMFORT

INCASSI / RECESSED



Sobrio e rigoroso nella forma, Comfort è un apparecchio ad incasso ideale per gli ambienti in cui è necessario ottenere un ottimo comfort visivo (UGR<19, standard UNI-11165 e EN 12464-1). Realizzato in alluminio pressofuso ed equipaggiato con sorgente LED ad alta efficienza a tecnologia Chip On Board e driver remoto, il suo grado di protezione contro la penetrazione di polvere, corpi solidi e liquidi è IP44.

Basic and rigorous design identify Comfort, a recessed light ideal for any environment requiring excellent visual comfort (UGR<19, standards UNI-11165 and EN 12464-1). This fixture is made from die-cast aluminium and equipped with a Chip On Board technology high efficiency LED light source and a remote driver. Its degree of protection against the penetration of dust, solid objects and liquids is IP44.

-  24°
-  3000K
-  44
-  93
-  A++
-  0
-  08 Bianco satinato
-  Driver incluso
Driver included

CODICE	W	Lm
A5-677.07.30	7	900
A5-677.12.30	12	1522

/DIMM2 dimmerabile protocollo DALI
/DIMM3 dimmerabile switch-DIM

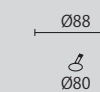
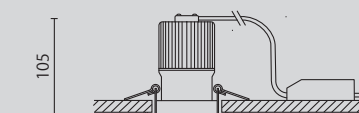



	45°
TC	3000K
IP	43
CRI	93
EEL	A++
RG	1
	Gesso Plaster
D	Driver incluso Driver included

DEDILUS

INCASSI / RECESSED

Realizzato in gesso, un materiale naturale ed ecologico che non emana sostanze nocive nell'ambiente, Dedilus è un eclettico apparecchio ad incasso per applicazioni a scomparsa. Il corpo in gesso viene stuccato a filo, intonato e rifinito con la parete, integrandosi perfettamente nell'ambiente. Disponibile in quattro versioni, è equipaggiato con sorgente LED ad alta efficienza e driver remoto. Il grado di protezione contro la penetrazione di polvere, corpi solidi e liquidi è IP43.

Dedilus is an all-around recessed light with an invisible trim which can be plastered and painted to match the wall. Available in four versions, it is made of gypsum, a natural and eco-friendly material which does not emit harmful substances. It is equipped with a high efficiency LED light source and a remote driver. Its degree of protection against the penetration of dust, solid objects and liquids is IP43.



DEDILUS PICCOLO QUADRO

CODICE	W	Lm
A5-685.07.30	7	780
A5-685.10.30	10	1025

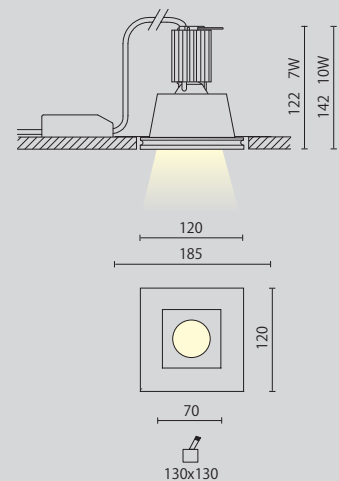

DEDILUS PICCOLO QUADRO

CODICE	W	Lm
A5-686.07.30	7	780
A5-686.10.30	10	1025

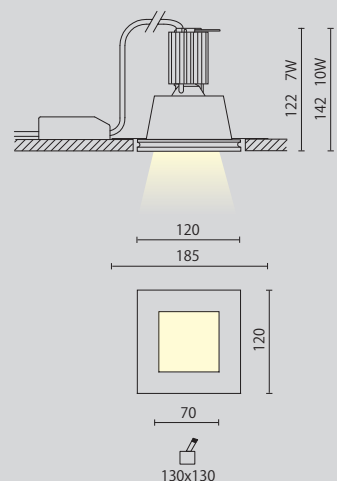

DEDILUS PICCOLO TONDO

CODICE	W	Lm
A5-687.07.30	7	780
A5-687.10.30	10	1025

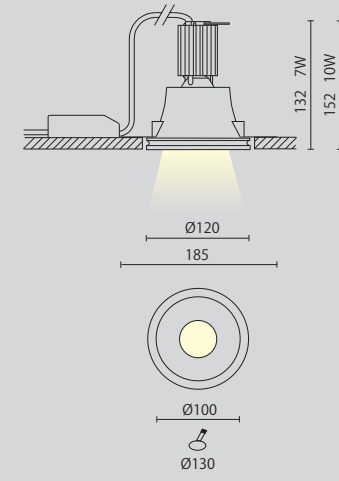

DEDILUS PICCOLO TONDO

CODICE	W	Lm
A5-688.07.30	7	780
A5-688.10.30	10	1025

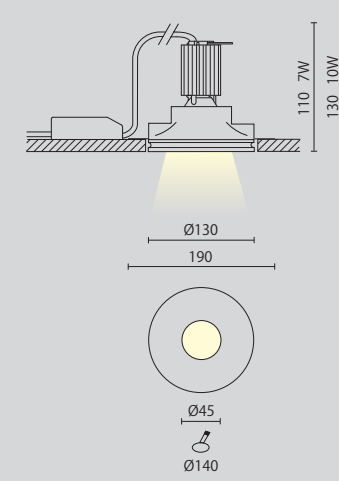



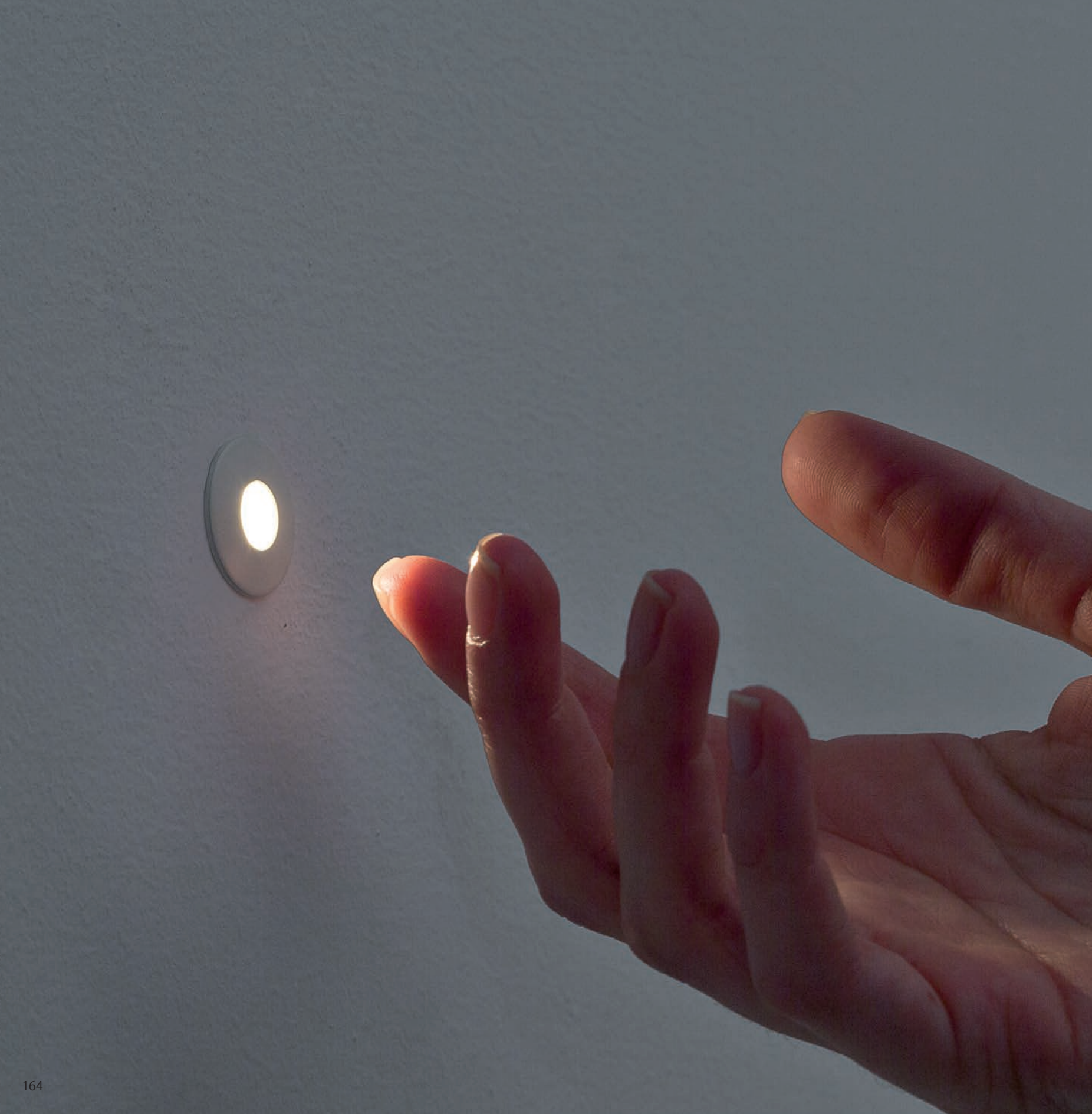

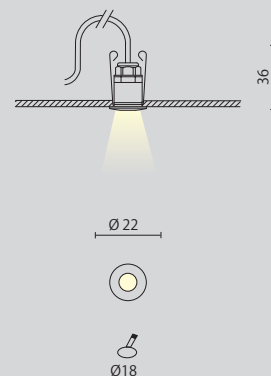

ZJ1

CODICE	W	Lm (3000K)	
A5-650...	0,3	25	60°
0506.1	controcassa (esclusa) / flush box (not included)		
driver escluso 12Vdc p. 301 / 12Vdc driver not included p. 301			



ZJ2

CODICE	W	Lm	
A5-651.30	3	150	40° (a richiesta 15°) (15° on request)
controcassa per calcestruzzo inclusa / flush mounting box for concrete included			
driver incluso 12Vdc / 12Vdc driver included			

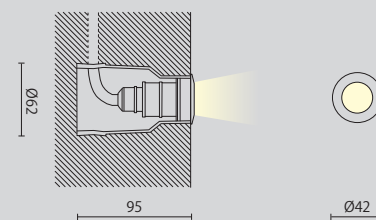

ZJ

INCASSI / RECESSED

Minuto e discreto, ideale per creare geometrie luminose anche negli spazi che richiedono un elevato grado di protezione da acqua e polvere, ZJ è un apparecchio da incasso con corpo in alluminio verniciato a polvere epossidica stabilizzata ai raggi UV o finito con un trattamento anodico. Disponibile in due dimensioni, è equipaggiato con sorgente LED ad alta efficienza. ZJ1 viene fornito senza driver, mentre ZJ2 ne è provvisto. Il grado di protezione contro la penetrazione di polvere, corpi solidi e liquidi è IP65.

ZJ is a tiny recessed light designed to create bright geometries in spaces with high levels of humidity or dust. It is made from natural anodized or epoxy powder coated aluminium stabilized with UV rays. Equipped with a high efficiency LED module, the ZJ1 version is provided with no driver, while the ZJ2 is furnished with it. Its degree of protection against the penetration of dust, solid objects and liquids is IP65.

	(vedi tabella) / (see table)
TC	ZJ1: 3000K / 6000K ZJ2: 3000K
IP	65
CRI	>80
EEL	A+
RG	0
08	Bianco satinato
20	Anodizzato naturale
D	(vedi tabella) / (see table)

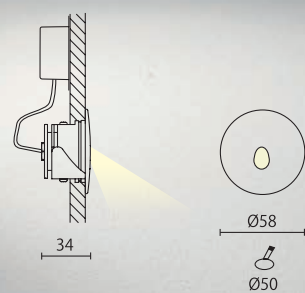

Controcassa per installazione in muratura
Wall mounting flush box

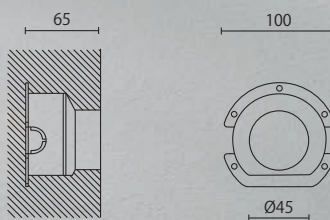

VELO TONDO

CODICE	W	Lm	
A5-600.03.30	3	160	35°

controcassa inclusa / flush box included

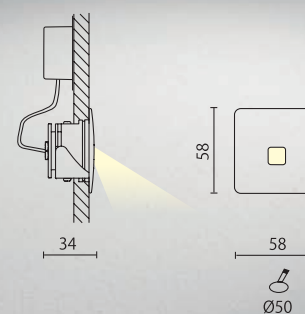

Controcassa per installazione in muratura
Wall mounting flush box

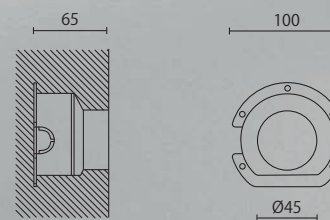

VELO QUADRO

CODICE	W	Lm	
A5-601.03.30	3	160	50°

controcassa inclusa / flush box included

VELO

INCASSI / RECESSED

Linee dolci ed essenziali, Velo è un segnapasso ad incasso con fascio luminoso asimmetrico. Realizzato in alluminio pressofuso verniciato a polvere epossipoliestere, è dotato di diffusore in policarbonato. E' fornito completo di sorgente a LED ad alta efficienza, driver e cassaforma. Il grado di protezione contro la penetrazione di polvere, corpi solidi e liquidi è IP55.

Gentle and essential lines identify Velo, a recessed step light with an asymmetrical beam. Made from die-cast epoxy polyester powder coated aluminium, this product is equipped with a polycarbonate diffuser, a high efficiency LED light source, driver and flush box. Its degree of protection against the penetration of dust, solid objects and liquids is IP55.

	(vedi tabella) (see table)
TC	3000K
IP	55
CRI	>80
EEL	A+
RG	0
08	Bianco satinato
D	Driver incluso Driver included

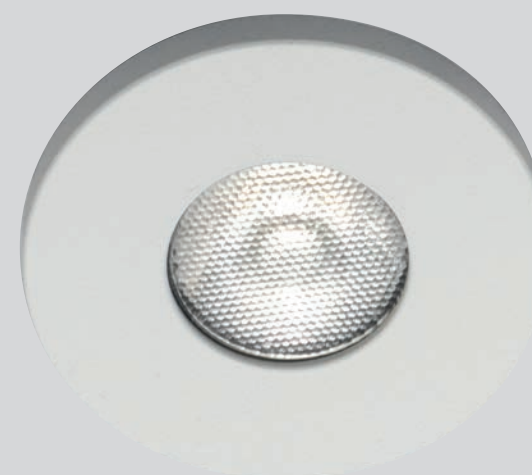

AMBO

INCASSI / RECESSED

Una forma armonica caratterizza Ambo-B e la discrezione identifica Ambo-A. Adatti per essere utilizzati anche come segnapassi, questi apparecchi ad incasso dalle dimensioni ridotte sono realizzati in alluminio verniciato a polvere epossipoliestere, con diffusore in policarbonato. Sono forniti completi di sorgente luminosa a LED e driver remoto. Il grado di protezione contro la penetrazione di polvere, corpi solidi e liquidi è IP40.

An harmonious shape characterizes Ambo-B and discretion identifies Ambo-A. These recessed lights, which are also suitable to be used as step lights, are made from epoxy polyester powder coated aluminium and they are equipped with a polycarbonate diffuser, a LED light source and a remote driver. Their degree of protection against the penetration of dust, solid objects and liquids is IP40.

	45° (a richiesta 25°) (25° on request)
TC	3000K
IP	40
CRI	>80
EEL	A+
RG	1
16	Bronzo anodizzato
08	Bianco satinato
D	Driver incluso Driver included

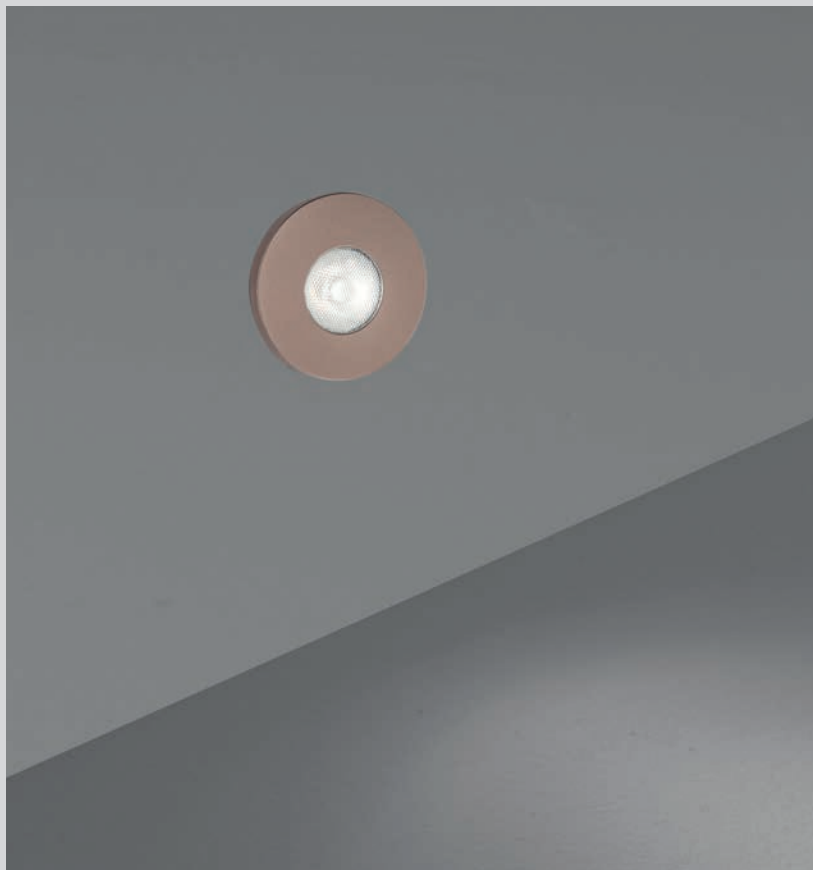

AMBO - A

CODICE	W	Lm
A5-656.30	3	150

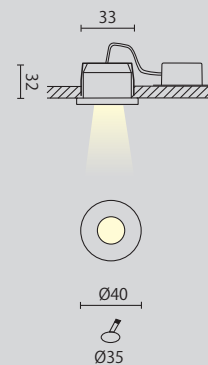

AMBO - B

CODICE	W	Lm
A5-655.30	3	150

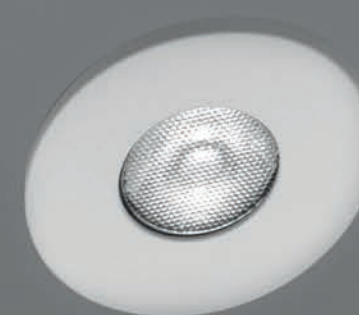
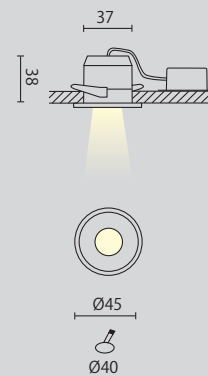

SISTEMI
SYSTEMS

TIMBER

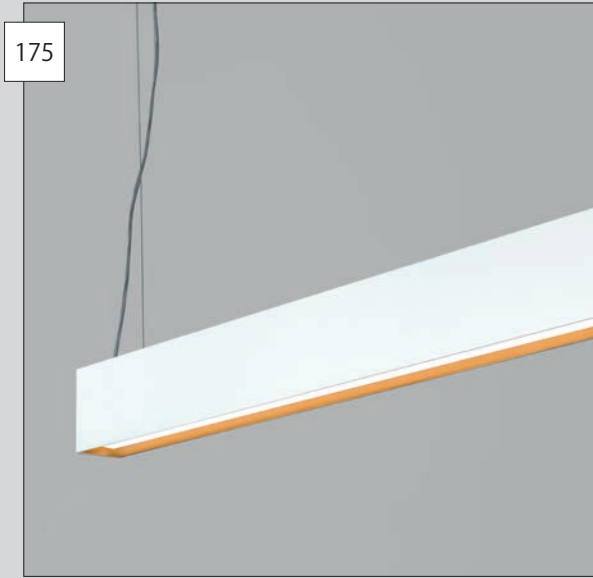

175

LINE INCASSO

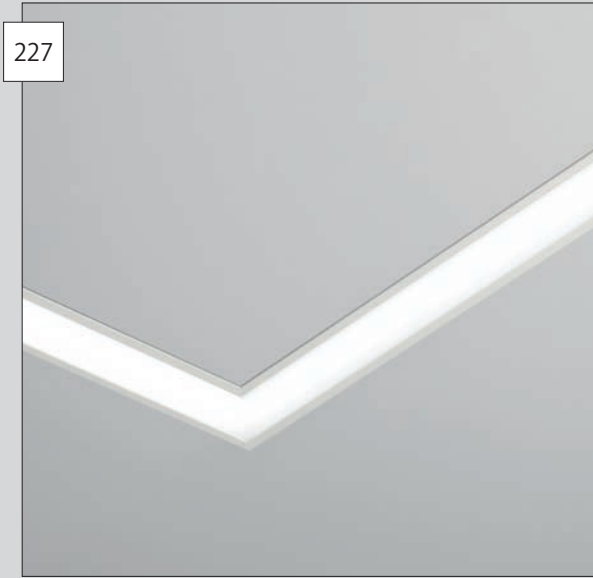

227

MINILINE



239

AT



247

ESPO'



257

FUSION SOSPENSIONE

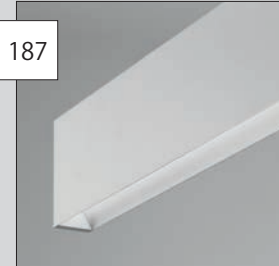

187

FUSION PLAFONE



193

ESPO' 2



263

FROY



269

LATY



273

FUSION INCASSO

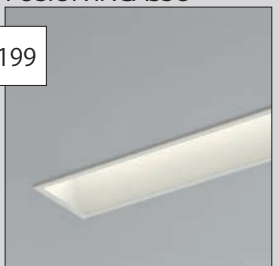

199

LINE SOSPENSIONE



213

LINE PLAFONE

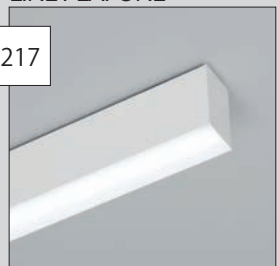

217

ASY



269



TIMBER

SISTEMA SOSPENSIONE / HANGING SYSTEM

Sobriet  formale e opportunit  di personalizzare il prodotto scegliendo sia il colore degli inserti (oro, bianco o nero), sia la lunghezza dell'apparecchio, fino ad un massimo di 4 metri. Timber   un modulo a sospensione componibile mono o biemissione completo di moduli a LED ad alta efficienza. Realizzato in alluminio estruso verniciato a polvere epossipoliestere con diffusore in policarbonato opalino, l'apparecchio   fornito di driver e di cablaggio a quattro conduttori passanti per due circuiti elettrici con neutro comune. L'installazione a sospensione avviene mediante l'utilizzo di cavetti di acciaio zincato (non inclusi), dotati di dispositivi a regolazione rapida. Per ottenere maggiore adattabilit    disponibile una vasta scelta di accessori. Disponibile nelle versioni emergenza tipo SA, autonomia 1h e dimmerabile DALI/switch-dim. Il grado di protezione contro la penetrazione di polvere, corpi solidi e liquidi   IP40.

A basic shape combined with the possibility of customizing the product by choosing both the colour of the inserts (gold, black or white) and the length of the extrusion, till a maximum of 4m. Timber is a modular single and double emission hanging luminaire complete with high efficiency LED modules and driver. It is made from epoxy polyester powder coated aluminium and it is equipped with an opal polycarbonate diffuser. The lamp is suspended with galvanized steel cables (not included) with quick-adjust regulation devices. A wide range of accessories is available to customize the system. The product includes wiring with four wires that pass through two electrical circuits with shared neutral. SA emergency version (1 hour of autonomy) and switch-dim/DALI dimmable version available on request. Its degree of protection against the penetration of dust, solid objects and liquids is IP40.

	↓75° / (↑100°)
TC	3000K / 4000K
IP	40
CRI	>80
EEL	A++
RG	0

COLORE PROFILO
BODY COLOUR

02	Nero opaco
08	Bianco satinato
46	Rovere sbiancato

COLORE INSERTO
COLOURED INSERT

T002	Nero opaco
T008	Bianco satinato
T013	Oro

TIMBER PRO LIGHT MONOEMISSIONE

CODICE	W	Lm (3000K)
A6-660PL.084...	27	3300
A6-660PL.112...	35	4400
A6-660PL.140...	44	5500
A6-660PL.168...	53	6600
A6-660PL.196...	62	7700
A6-660PL.224...	71	8800
A6-660PL.252...	80	9900
A6-660PL.280...	88	11000

/DIMM2 dimmerabile protocollo DALI
/DIMM3 dimmerabile switch-DIM
/EM modulo in emergenza (a richiesta / *on request*)
accessori esclusi p. 184 / *accessories not included p. 184*

TIMBER PRO LIGHT BIEMISSIONE

CODICE	W	Lm (3000K)
A6-660PL.2.084...	2x27	2x3300
A6-660PL.2.112...	2x35	2x4400
A6-660PL.2.140...	2x44	2x5500
A6-660PL.2.168...	2x53	2x6600
A6-660PL.2.196...	2x62	2x7700
A6-660PL.2.224...	2x71	2x8800
A6-660PL.2.252...	2x80	2x9900
A6-660PL.2.280...	2x88	2x11000

/DIMM2 dimmerabile protocollo DALI
/DIMM3 dimmerabile switch-DIM
/EM modulo in emergenza (a richiesta / *on request*)
doppia accensione / *double switch*
accessori esclusi p. 184 / *accessories not included p. 184*

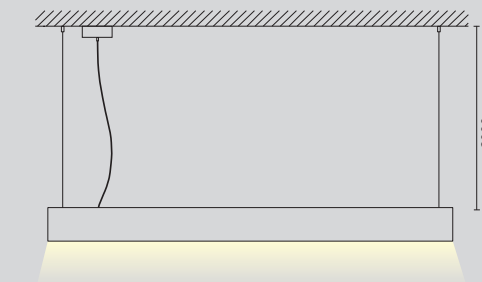

mm	codice
845*	A6-660PL.084
1125*	A6-660PL.112
1405*	A6-660PL.140
1685*	A6-660PL.168
1965*	A6-660PL.196
2245*	A6-660PL.224
2525*	A6-660PL.252
2805*	A6-660PL.280

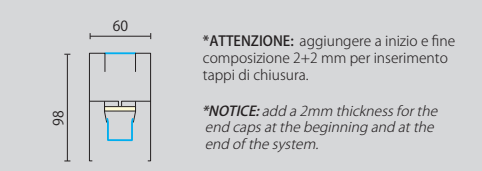

***ATTENZIONE:** aggiungere a inizio e fine composizione 2+2 mm per inserimento tappi di chiusura.
***NOTICE:** add a 2mm thickness for the end caps at the beginning and at the end of the system.

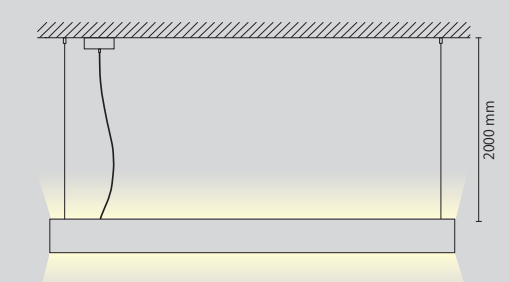

mm	codice
845*	A6-660PL.2.084
1125*	A6-660PL.2.112
1405*	A6-660PL.2.140
1685*	A6-660PL.2.168
1965*	A6-660PL.2.196
2245*	A6-660PL.2.224
2525*	A6-660PL.2.252
2805*	A6-660PL.2.280

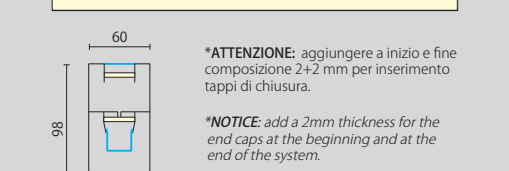

***ATTENZIONE:** aggiungere a inizio e fine composizione 2+2 mm per inserimento tappi di chiusura.
***NOTICE:** add a 2mm thickness for the end caps at the beginning and at the end of the system.



Decox, elettrodomestici

TIMBER SOFT MONOEMISSIONE

CODICE	W	Lm (3000K)
A6-660S.084...	18	2430
A6-660S.112...	24	3250
A6-660S.140...	30	4060
A6-660S.168...	36	4870
A6-660S.196...	42	5680
A6-660S.224...	48	6500
A6-660S.252...	54	7310
A6-660S.280...	60	8120

/DIMM2 dimmerabile protocollo DALI } non disponibile per cod. A6-660S.084
 /DIMM3 dimmerabile switch-DIM } not available for code A6-660S.084
 /EM modulo in emergenza (a richiesta / on request)
 accessori esclusi p. 184 / accessories not included p. 184

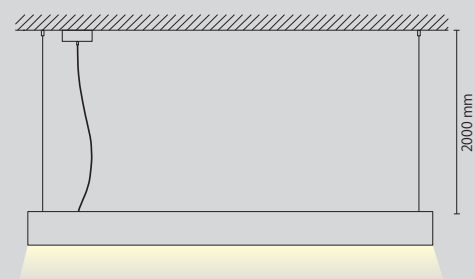

mm	codice
845*	A6-660S.084
1125*	A6-660S.112
1405*	A6-660S.140
1685*	A6-660S.168
1965*	A6-660S.196
2245*	A6-660S.224
2525*	A6-660S.252
2805*	A6-660S.280

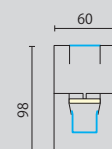

***ATTENZIONE:** aggiungere a inizio e fine composizione 2+2 mm per inserimento tappi di chiusura.

***NOTICE:** add a 2mm thickness for the end caps at the beginning and at the end of the system.

TIMBER SOFT BIEMISSIONE

CODICE	W	Lm (3000K)
A6-660S.2.084...	2x18	2x2430
A6-660S.2.112...	2x24	2x3250
A6-660S.2.140...	2x30	2x4060
A6-660S.2.168...	2x36	2x4870
A6-660S.2.196...	2x42	2x5680
A6-660S.2.224...	2x48	2x6500
A6-660S.2.252...	2x54	2x7310
A6-660S.2.280...	2x60	2x8120

/DIMM2 dimmerabile protocollo DALI } non disponibile per cod. A6-660S.2.084
 /DIMM3 dimmerabile switch-DIM } not available for code A6-660S.2.084
 /EM modulo in emergenza (a richiesta / on request)
 doppia accensione / double switch
 accessori esclusi p. 184 / accessories not included p. 184

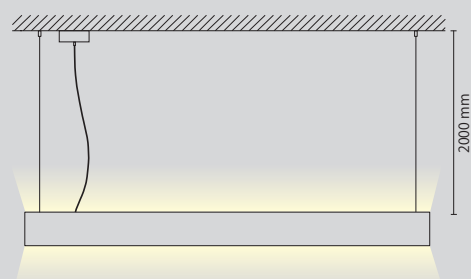

mm	codice
845*	A6-660S.2.084
1125*	A6-660S.2.112
1405*	A6-660S.2.140
1685*	A6-660S.2.168
1965*	A6-660S.2.196
2245*	A6-660S.2.224
2525*	A6-660S.2.252
2805*	A6-660S.2.280

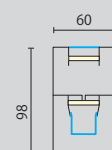

***ATTENZIONE:** aggiungere a inizio e fine composizione 2+2 mm per inserimento tappi di chiusura.

***NOTICE:** add a 2mm thickness for the end caps at the beginning and at the end of the system.



TIMBER

CORPO IN ALLUMINIO ESTRUSO
(Nero opaco, Bianco satinato, Rovere sbiancato)
EXTRUDED ALUMINIUM BAR
(Matt Black, Frosted White, Whitened durmast)

EMMISSIONE INDIRETTA INDIRECT LIGHTING

SCHERMO IN POLICARBONATO / POLYCARBONATE SCREEN

MODULO LED / LED MODULE

BIADESIVO TERMICO / DOUBLE-SIDED THERMAL ADHESIVE TAPE

DISSIPATORE IN ALLUMINIO / ALUMINIUM HEAT-SINK

EMMISSIONE DIRETTA DIRECT LIGHTING

BIADESIVO TERMICO / DOUBLE-SIDED THERMAL ADHESIVE TAPE

MODULO LED / LED MODULE

INSERTI (Nero opaco, Bianco satinato, Oro)
INSERTS (Matt Black, Frosted white, Gold)

DIFFUSORE IN POLICARBONATO / POLYCARBONATE DIFFUSER

CODICE DESCRIZIONE / DESCRIPTION

ACCESSORI SISTEMA SOSPENSIONE / HANGING SYSTEM ACCESSORIES

A6-045	Terminali di chiusura (coppia). Colore 02-08-46. Colore inserti T002-T008-T013 <i>End caps (pair). Colour 02-08-46. Coloured insert T002-T008-T013</i>
A6-019.3	Rosone con cavo di alimentazione 3x0,75 mm ² 200cm. Colore 02-08 <i>Ceiling cup with supply cable 3x0,75mm² 200 cm. Colour 02-08</i>
A6-019.4	Rosone con cavo di alimentazione 4x0,75 mm ² 200cm per installazioni con doppia accensione. Colore 02-08 <i>Ceiling cup with supply cable 4x0,75mm² 200 cm, for double switch use. Colour 02-08</i>
A6-019.5	Rosone con cavo di alimentazione 5x0,75 mm ² 200cm per installazioni dimmerabili o in emergenza. Colore 02-08 <i>Ceiling cup with supply cable 5x0,75mm² 200 cm, for dimming and emergency use. Colour 02-08</i>
A6-036	Cavi di sospensione 200cm. La frequenza dei cavi è consigliabile ogni metro <i>Suspension cables, 200 cm. Should be spaced one meter apart</i>
A6-047	Giunto lineare <i>In-line connector</i>
A6-048...	Curva 90° (vedere tabella). Colore 02-08-46. Colore inserti T002-T008-T013 <i>90° corner (see table). Colour 02-08-46. Coloured insert T002-T008-T013</i>

CODICE W Lm (3000K)

MONOEMISSIONE / SINGLE EMISSION

A6-048PL.30 (Pro light)	35	4400
A6-048S.30 (Soft)	24	3250

BIEMISSIONE / DOUBLE EMISSION

A6-048PL.2.30 (Pro light)	2x35	2x4400
A6-048S.2.30 (Soft)	2x24	2x3250

.40 per 4000K

/DIMM2 dimmerabile protocollo DALI

/DIMM3 dimmerabile switch-DIM

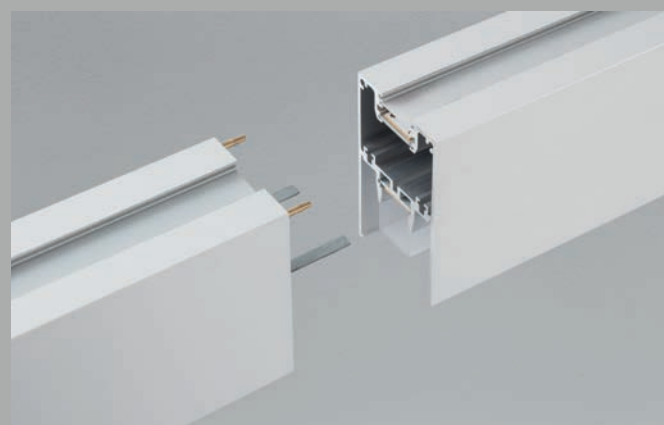
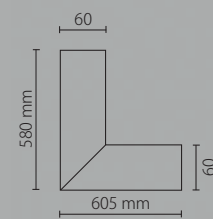

Giunto lineare / In-line connector

TIMBER

ACCESSORI / ACCESSORIES





FUSION

SISTEMA SOSPENSIONE / HANGING SYSTEM

Discreto ed essenziale, commissionabile in lunghezze su misura, Fusion è un modulo a sospensione componibile bidiffusione, completo di sorgente a LED ad alta efficienza e di driver. Realizzato in alluminio estruso verniciato a polvere epossipoliestere e fornito di diffusore in policarbonato opalino, l'apparecchio è fornito di cablaggio a quattro conduttori passanti per due circuiti elettrici con neutro comune. L'installazione a sospensione avviene mediante l'utilizzo di cavetti di acciaio zincato (non inclusi), dotati di dispositivi a regolazione rapida. Per ottenere maggiore adattabilità è disponibile una vasta scelta di accessori. Richiedibile nelle versioni emergenza tipo SA, autonomia 1h e dimmerabile DALI/switch-dim. Il grado di protezione contro la penetrazione di polvere, corpi solidi e liquidi è IP40. Possibilità di sostituire il diffusore opalino con una lente di fascio 30° che, riducendo la luminanza diretta dell'apparecchio, rende Fusion adatto all'installazione in ambienti in cui viene richiesto un UGR<19 (normativa UNI-11165 e UNI 12464-1), quali uffici o postazioni con videotermini.

The concept of linearity applied to a modular double diffusion hanging lamp. Fusion is made from epoxy polyester powder coated aluminium and it is equipped with a frosted light diffuser, high efficiency LED modules and driver. The lamp is suspended with galvanized steel cables (not included) with quick-adjust regulation devices. A wide range of accessories is available to customize the system. This product includes wiring with four wires that pass through two electrical circuits with shared neutral. 30° lens reducing the luminaire's direct lighting (UGR<19, standards UNI-11165 and EN 12464-1), SA emergency version (1 hour of autonomy) and switch-dim/DALI dimmable version available on request. Its degree of protection against the penetration of dust, solid objects and liquids is IP40.

FUSION PRO BIDIFFUSIONE

CODICE	W	Lm (3000K)
A6-607.2.084...	2x30	2x3960
A6-607.2.112...	2x40	2x5280
A6-607.2.140...	2x50	2x6600
A6-607.2.168...	2x60	2x7920
A6-607.2.196...	2x70	2x9240
A6-607.2.224...	2x80	2x10560
A6-607.2.252...	2x90	2x11880
A6-607.2.280...	2x100	2x13200
LE001-30/100*	lente fascio 30° / 30° lens	

/DIMM2 dimmerabile protocollo DALI

/DIMM3 dimmerabile switch-DIM

/EM modulo in emergenza

doppia accensione, *codice al metro / double switch, *code per meter
accessori esclusi p. 210 / accessories not included p. 210

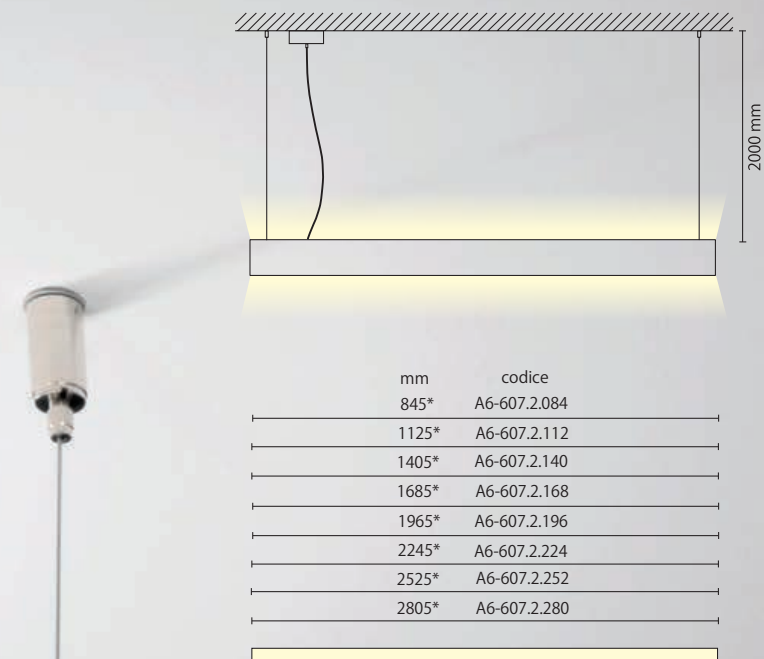

mm	codice
845*	A6-607.2.084
1125*	A6-607.2.112
1405*	A6-607.2.140
1685*	A6-607.2.168
1965*	A6-607.2.196
2245*	A6-607.2.224
2525*	A6-607.2.252
2805*	A6-607.2.280

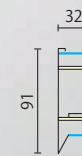

***ATTENZIONE:** aggiungere a inizio e fine composizione 1,8 mm di spessore per i tappi di chiusura.
Codifica: cod. prodotto/T=1 tappo
cod. prodotto/TT=2 tappi

***NOTICE:** add 1,8mm thickness for the end caps to the beginning and the end of the system.
Product code/T=1 end cap
Product code/TT=2 end caps



	↓ 70° (a richiesta 30°) ↑ 120° (30° on request)
TC	3000K / 4000K
IP	40
CRI	>80
EEL	A++
RG	0
08	Bianco satinato

FUSION PRO LIGHT BIDIFFUSIONE

CODICE	W	Lm (3000K)
A6-606.2.084...	2x27	2x3300
A6-606.2.112...	2x35	2x4400
A6-606.2.140...	2x44	2x5500
A6-606.2.168...	2x53	2x6600
A6-606.2.196...	2x62	2x7700
A6-606.2.224...	2x71	2x8800
A6-606.2.252...	2x80	2x9900
A6-606.2.280...	2x88	2x11000
LE001-30/100*	lente fascio 30° / 30° lens	

/DIMM2 dimmerabile protocollo DALI

/DIMM3 dimmerabile switch-DIM

doppia accensione, *codice al metro / double switch, *code per meter
accessori esclusi p. 210 / accessories not included p. 210

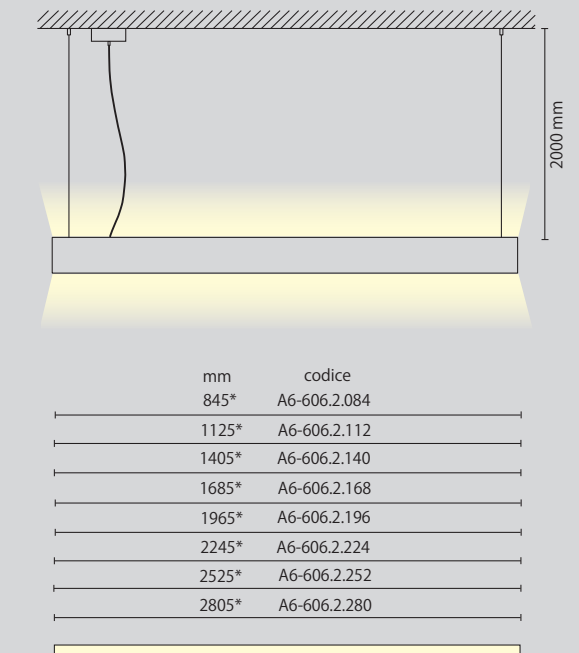

mm	codice
845*	A6-606.2.084
1125*	A6-606.2.112
1405*	A6-606.2.140
1685*	A6-606.2.168
1965*	A6-606.2.196
2245*	A6-606.2.224
2525*	A6-606.2.252
2805*	A6-606.2.280



***ATTENZIONE:** aggiungere a inizio e fine composizione 1,8 mm di spessore per i tappi di chiusura.
Codifica: cod. prodotto/T=1 tappo
cod. prodotto/TT=2 tappi

***NOTICE:** add 1,8 mm thickness for the end caps to the beginning and the end of the system.
Product code/T=1 end cap
Product code/TT=2 end caps

FUSION

SOSPENSIONE BIDIFFUSIONE
DOUBLE EMISSION HANGING SYSTEM

CORPO IN ALLUMINIO ESTRUSO (Bianco satinato)
EXTRUDED ALUMINIUM BAR (Frosted White)

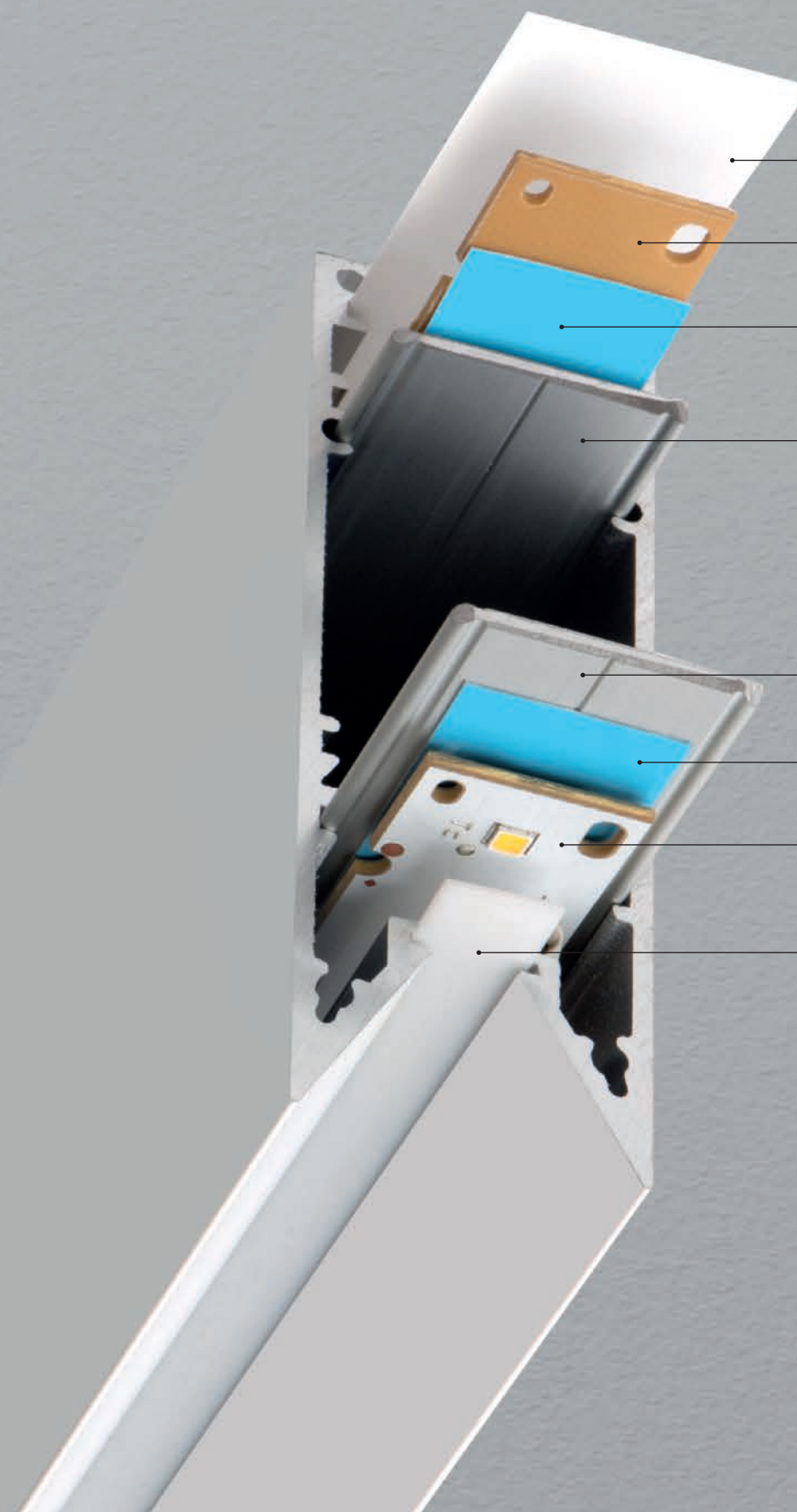

DIFFUSORE IN POLICARBONATO / POLYCARBONATE DIFFUSER

MODULO LED / LED MODULE

BIADESIVO TERMICO / DOUBLE-SIDED THERMAL ADHESIVE TAPE

DISSIPATORE IN ALLUMINIO / ALUMINIUM HEAT-SINK

BIADESIVO TERMICO / DOUBLE-SIDED THERMAL ADHESIVE TAPE

MODULO LED / LED MODULE

DIFFUSORE IN POLICARBONATO (A richiesta può essere sostituito con lente fascio 30°)
POLYCARBONATE DIFFUSER (Replaceable on request with a 30° lens)

FUSION PRO

CODICE	W	Lm (3000K)
A6-617.084...	30	3960
A6-617.112...	40	5280
A6-617.140...	50	6600
A6-617.168...	60	7920
A6-617.196...	70	9240
A6-617.224...	80	10560
A6-617.252...	90	11880
A6-617.280...	100	13200
LE001-30/100*	lente fascio 30° / 30° lens	

/DIMM2 dimmerabile protocollo DALI

/DIMM3 dimmerabile switch-DIM

/EM modulo in emergenza

*codice al metro / *code per meter

accessori esclusi p. 210 / accessories not included p. 210

FUSION PRO LIGHT

CODICE	W	Lm (3000K)
A6-616.084...	27	3300
A6-616.112...	35	4400
A6-616.140...	44	5500
A6-616.168...	53	6600
A6-616.196...	62	7700
A6-616.224...	71	8800
A6-616.252...	80	9900
A6-616.280...	88	11000
LE001-30/100*	lente fascio 30° / 30° lens	

/DIMM2 dimmerabile protocollo DALI

/DIMM3 dimmerabile switch-DIM

/EM modulo in emergenza

*codice al metro / *code per meter

accessori esclusi p. 210 / accessories not included p. 210

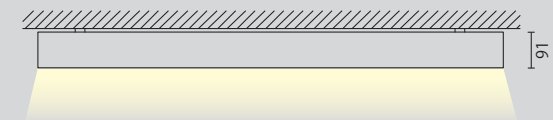

mm	codice
845*	A6-617.084
1125*	A6-617.112
1405*	A6-617.140
1685*	A6-617.168
1965*	A6-617.196
2245*	A6-617.224
2525*	A6-617.252
2805*	A6-617.280

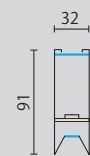

***ATTENZIONE:** aggiungere a inizio e fine composizione 1,8 mm di spessore per i tappi di chiusura.
Codifica: cod. prodotto/T=1 tappo
cod. prodotto/TT=2 tappi

***NOTICE:** add 1,8 mm thickness for the end caps to the beginning and the end of the system.
Product code/T=1 end cap
Product code/TT=2 end caps

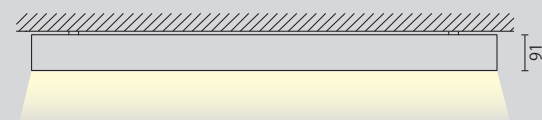

mm	codice
845*	A6-616.084
1125*	A6-616.112
1405*	A6-616.140
1685*	A6-616.168
1965*	A6-616.196
2245*	A6-616.224
2525*	A6-616.252
2805*	A6-616.280

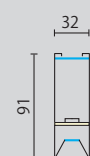

***ATTENZIONE:** aggiungere a inizio e fine composizione 1,8 mm di spessore per i tappi di chiusura.
Codifica: cod. prodotto/T=1 tappo
cod. prodotto/TT=2 tappi

***NOTICE:** add 1,8mm thickness for the end caps to the beginning and the end of the system.
Product code/T=1 end cap
Product code/TT=2 end caps



	70° (a richiesta 30°) (30° on request)
TC	3000K / 4000K
IP	40
CRI	>80
EEL	A++
RG	0
08	Bianco satinato

FUSION

SISTEMA PLAFONE / CEILING SYSTEM

Caratterizzato da una linea di luce messa in evidenza dal volume dell'apparecchio, Fusion è un modulo a plafone monoemissione, commissionabile in lunghezze su misura. Realizzato in alluminio estruso verniciato a polvere epossipoliestere e provvisto di diffusore in policarbonato opalino, viene fornito completo di sorgente a LED ad alta efficienza, driver e cablaggio a quattro conduttori passanti per due circuiti elettrici con neutro comune. L'installazione avviene mediante l'utilizzo di accessori in acciaio zincato inclusi. Per ottenere maggiore adattabilità è disponibile una vasta scelta di accessori. Richiedibile nelle versioni emergenza tipo SA, autonomia 1h e dimmerabile DALI/switch-dim. Il grado di protezione contro la penetrazione di polvere, corpi solidi e liquidi è IP40. Possibilità di sostituire il diffusore opalino con una lente di fascio 30° che, riducendo la luminanza diretta dell'apparecchio, rende Fusion adatto all'installazione in ambienti in cui viene richiesto un UGR<19 (normativa UNI-11165 e UNI 12464-1), quali uffici o postazioni con videotermini.

A line of light emphasized by the volume of the luminaire. Fusion is a modular single emission ceiling lamp made from epoxy polyester powder coated aluminium and it is equipped with a frosted light diffuser, high efficiency LED modules and driver. The lamp is suspended with galvanized steel cables (not included) with quick-adjust regulation devices. A wide range of accessories is available to customize the system. This product includes wiring with four wires that pass through two electrical circuits with shared neutral. 30° lens reducing the luminaire's direct lighting (UGR<19, standards UNI-11165 and EN 12464-1), SA emergency version (1 hour of autonomy) and switch-dim/DALI dimmable version available on request. Its degree of protection against the penetration of dust, solid objects and liquids is IP40.

FUSION

PLAFONE
CEILING SYSTEM

CORPO IN ALLUMINIO ESTRUSO (Bianco satinato)
EXTRUDED ALUMINIUM BAR (Frosted White)

COPERTURA IN ALLUMINIO / ALUMINIUM COVERING

DISSIPATORE IN ALLUMINIO / ALUMINIUM HEAT-SINK

BIADESIVO TERMICO / DOUBLE-SIDED THERMAL ADHESIVE TAPE

MODULO LED / LED MODULE

DIFFUSORE IN POLICARBONATO (A richiesta può essere sostituito con lente fascio 30°)
POLYCARBONATE DIFFUSER (Replaceable on request with a 30° lens)

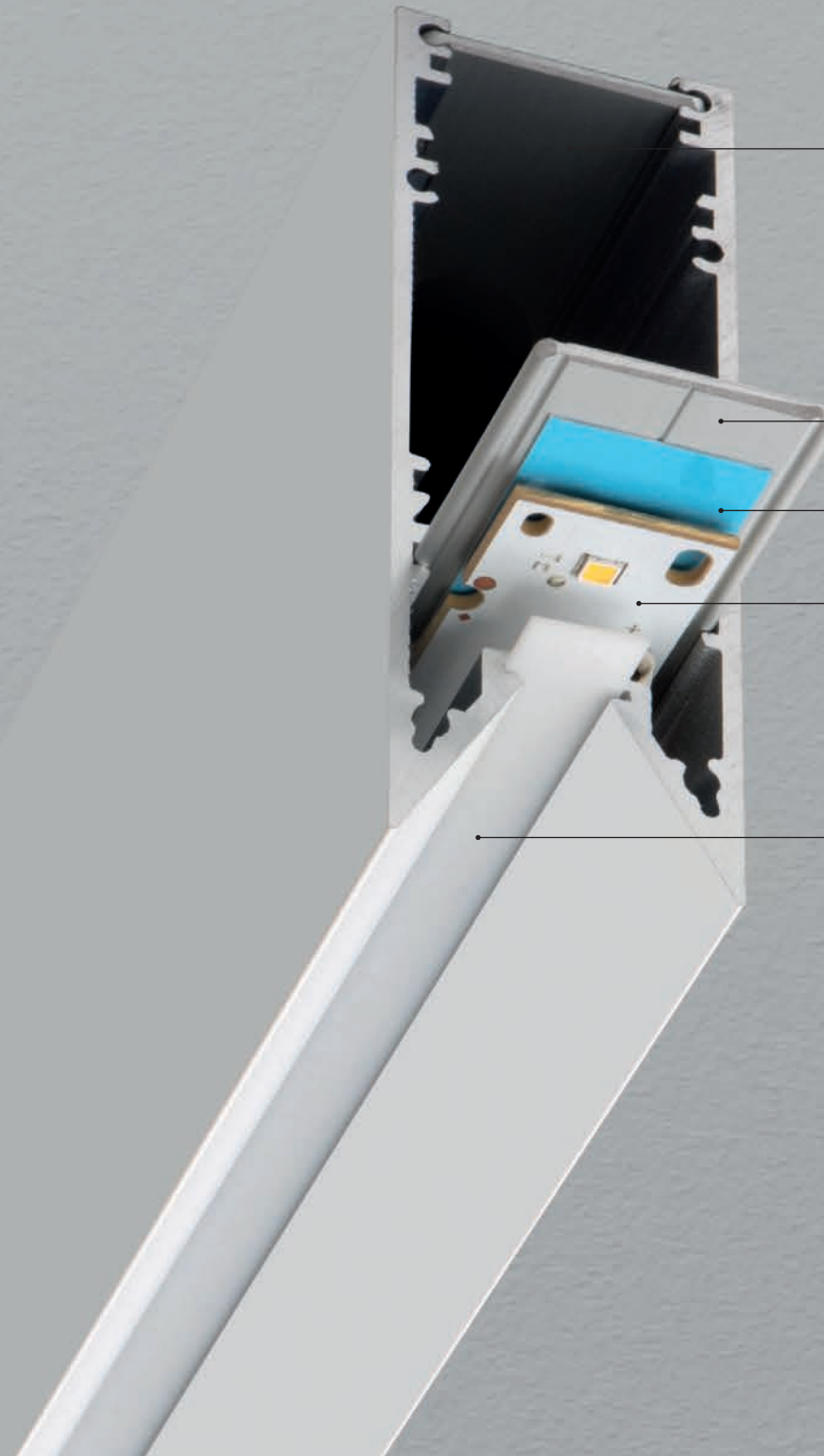

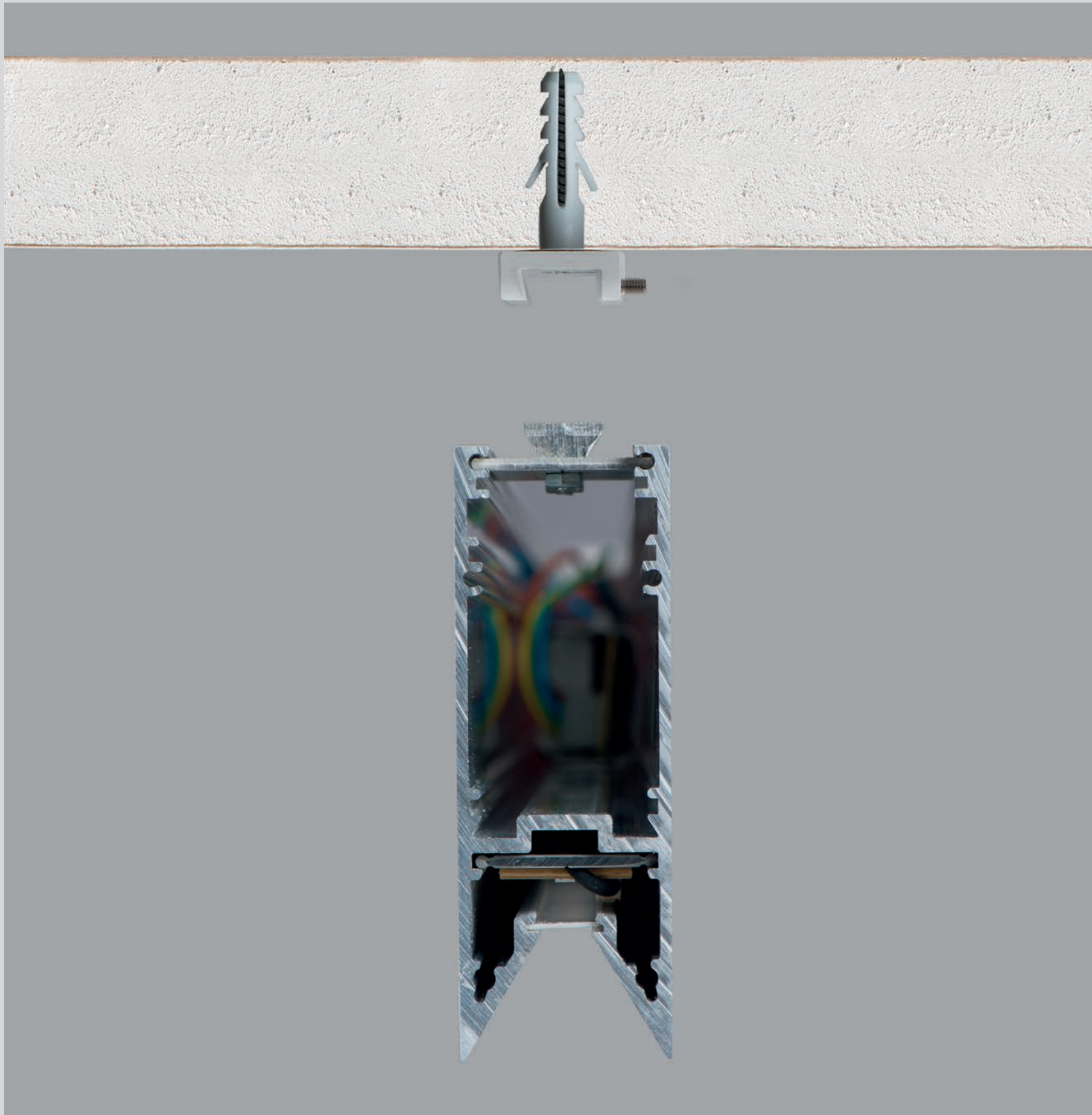



FUSION

SISTEMA INCASSO / RECESSED SYSTEM

Ideale per unire l'utilità della fonte di illuminazione all'alleggerimento visivo creato dai tagli luminosi, Fusion è un sistema componibile ad incasso disponibile nelle versioni con o senza bordo e commissionabile in lunghezze su misura. Realizzato in alluminio estruso verniciato a polvere epossipoliestere e provvisto di diffusore in policarbonato opalino, viene fornito completo di sorgente a LED ad alta efficienza, driver (Fusion incasso con bordo) e cablaggio a quattro conduttori passanti per due circuiti elettrici con neutro comune. L'installazione avviene mediante l'utilizzo di accessori in acciaio zincato inclusi. Per ottenere maggiore adattabilità è disponibile una vasta scelta di accessori. Richiedibile nelle versioni emergenza tipo SA, autonomia 1h e dimmerabile DALI/switch-dim. Il grado di protezione contro la penetrazione di polvere, corpi solidi e liquidi è IP40. Possibilità di sostituire il diffusore opalino con una lente di fascio 30° che, riducendo la luminanza diretta dell'apparecchio, rende Fusion adatto all'installazione in ambienti in cui viene richiesto un UGR<19 (normativa UNI-11165 e UNI 12464-1), quali uffici o postazioni con videotermini.

Designed to create enlightening cuts in solid surfaces, Fusion is a modular single emission recessed lamp made from epoxy polyester powder coated aluminium and it is equipped with a frosted light diffuser, high efficiency LED modules and driver (Fusion recessed with trim). A wide range of accessories is available to customize the system. This product includes wiring with four wires that pass through two electrical circuits with shared neutral. 30° lens reducing the luminaire's direct lighting (UGR<19, standards UNI-11165 and EN 12464-1), SA emergency version (1 hour of autonomy) and switch-dim/DALI dimmable version available on request. Its degree of protection against the penetration of dust, solid objects and liquids is IP40.

	70° (a richiesta 30°) (30° on request)
TC	3000K / 4000K
IP	40
CRI	>80
EEL	A++
RG	0
08	Bianco satinato

FUSION 24 SENZA BORDO / TRIMLESS

CODICE	W	Lm (3000K)
A6-639.100*...	31	3000
LE001-30/100*	lente fascio 30° / 30° lens	

controcassa inclusa / flush box included

*codice al metro / *code per meter

driver 24Vdc remoto, escluso p. 301 / remote driver not included p. 301

accessori esclusi p. 210 / accessories not included p. 210

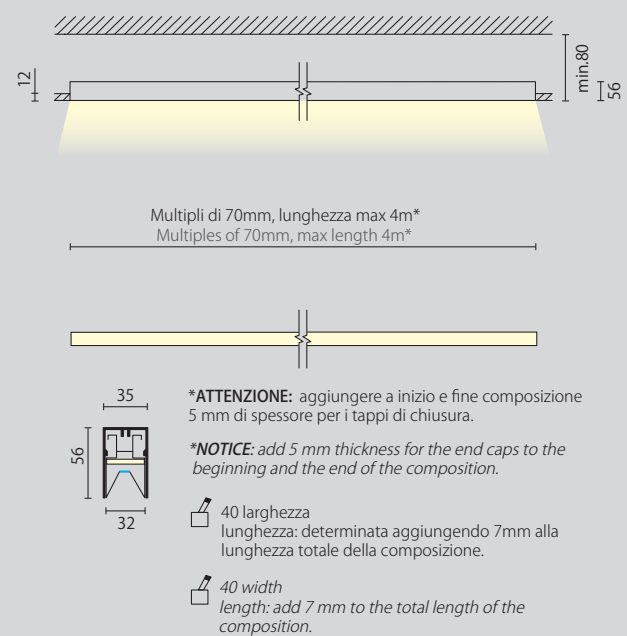

FUSION PRO LIGHT CON BORDO / WITH TRIM

CODICE	W	Lm (3000K)
A6-636.084...	27	3300
A6-636.112...	35	4400
A6-636.140...	44	5500
A6-636.168...	53	6600
A6-636.196...	62	7700
A6-636.224...	71	8800
A6-636.252...	80	9900
A6-636.280...	88	11000
LE001-30/100*	lente fascio 30° / 30° lens	

/DIMM2 dimmerabile protocollo DALI

/DIMM3 dimmerabile switch-DIM

/EM modulo in emergenza

*codice al metro / *code per meter

accessori esclusi p. 210 / accessories not included p. 210

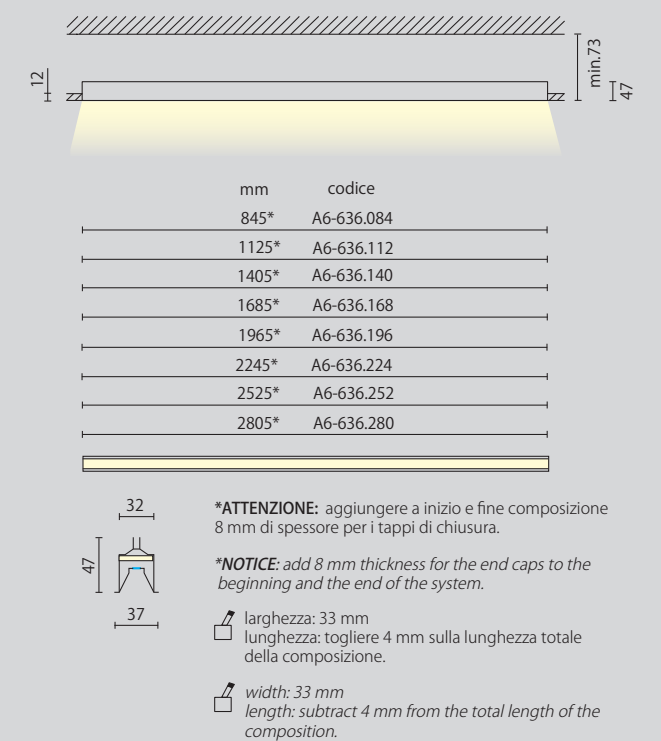

FUSION

INCASSO SENZA BORDO
TRIMLESS RECESSED SYSTEM

CORPO IN ALLUMINIO ESTRUSO (Bianco satinato)
EXTRUDED ALUMINIUM BAR (Frosted White)

CONTROCASSA IN ALLUMINIO ESTRUSO (Bianco satinato)
EXTRUDED ALUMINIUM FLUSH BOX (Frosted White)

DISSIPATORE IN ALLUMINIO / ALUMINIUM HEAT-SINK

BIADESIVO TERMICO / DOUBLE-SIDED THERMAL ADHESIVE TAPE

MODULO LED / LED MODULE

DIFFUSORE IN POLICARBONATO (A richiesta può essere sostituito con lente fascio 30°)
POLYCARBONATE DIFFUSER (Replaceable on request with a 30° lens)

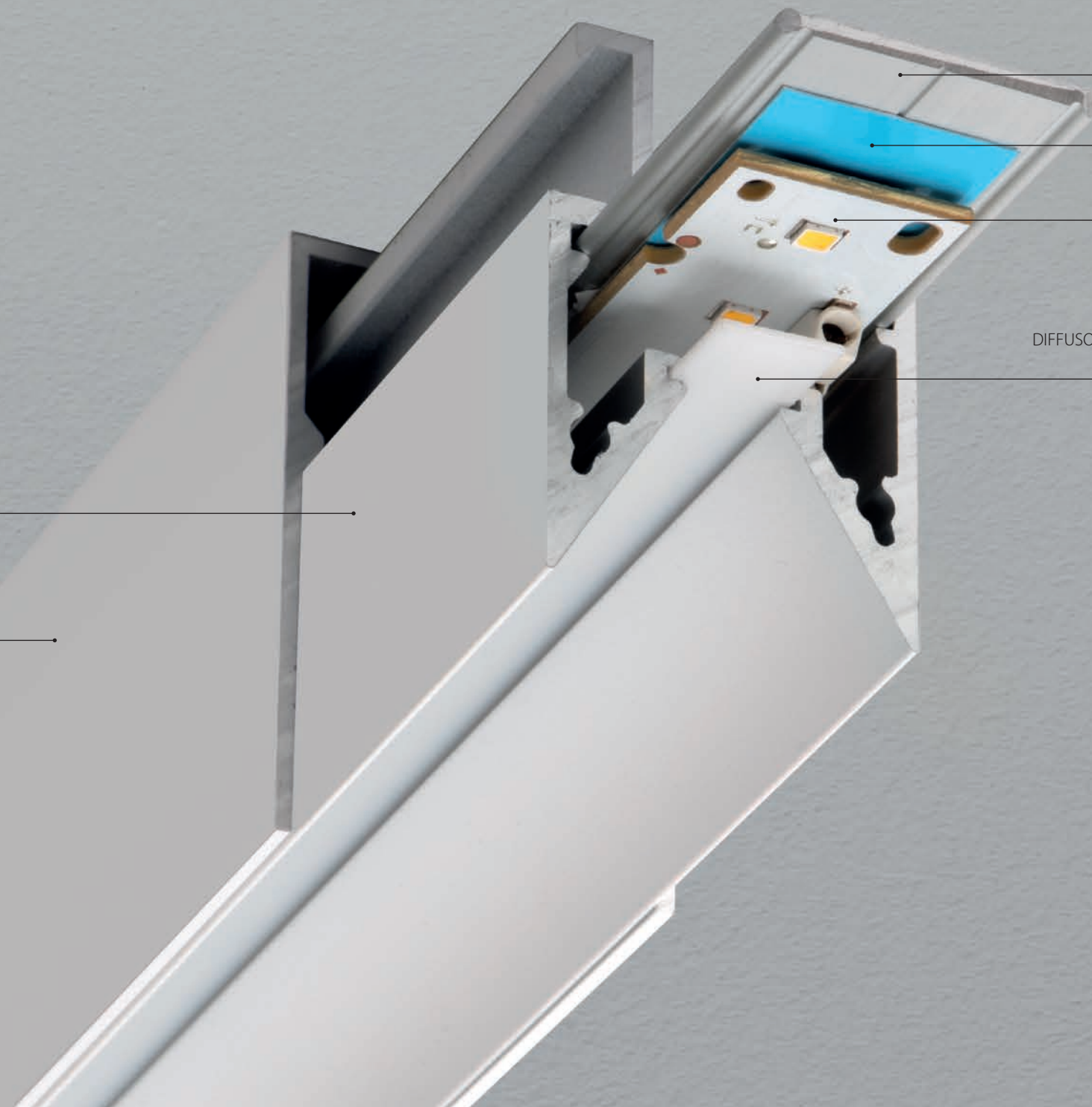

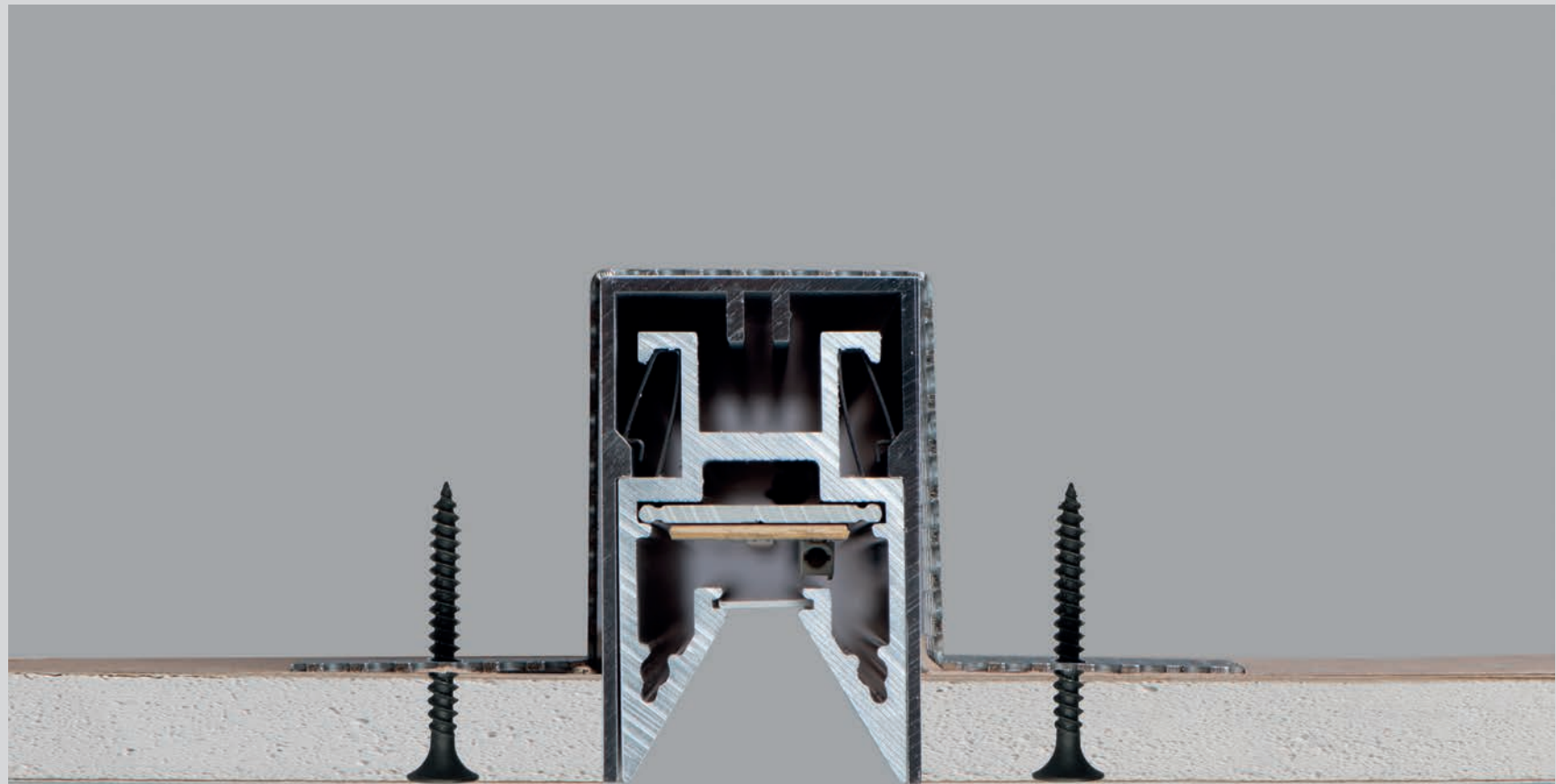
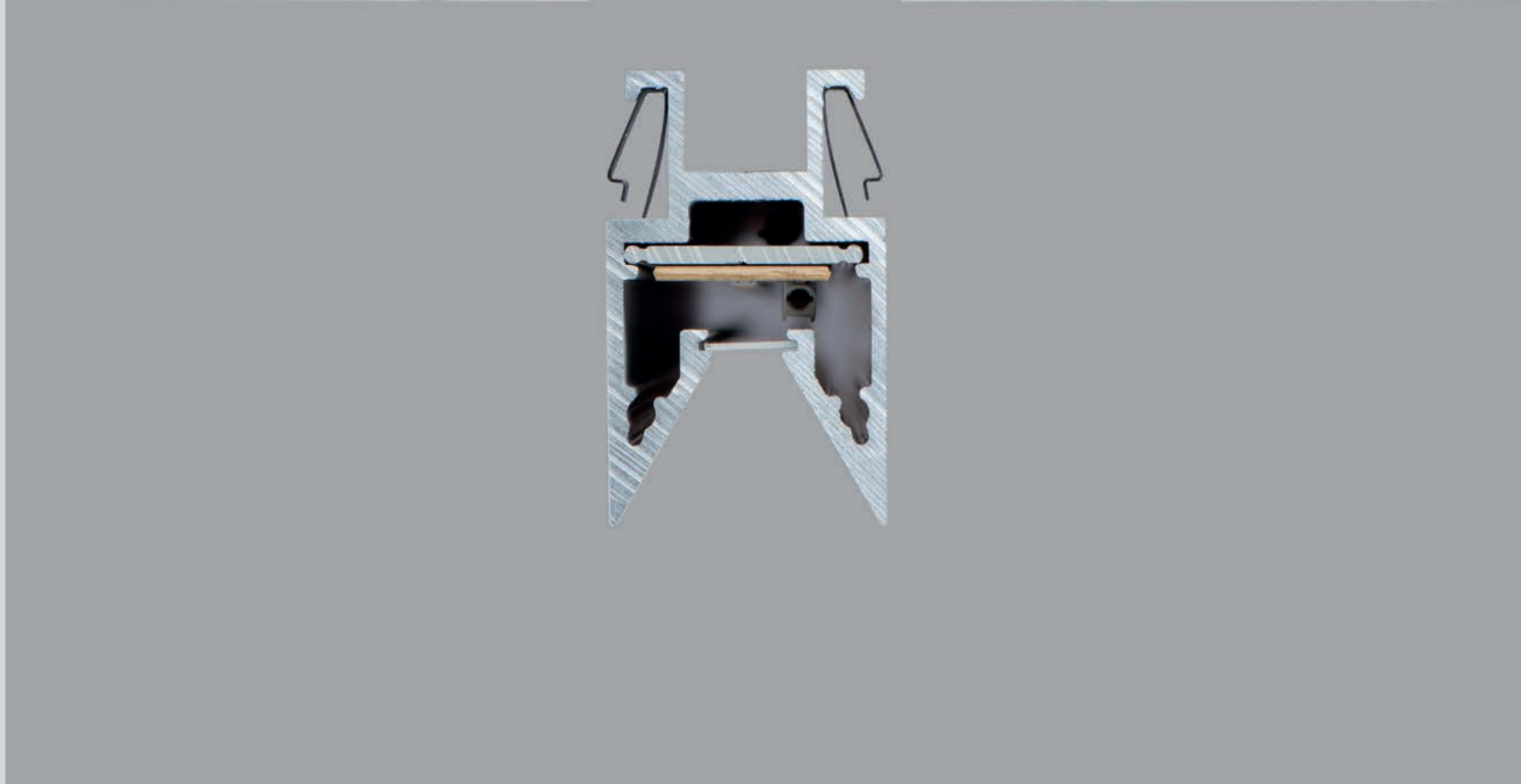
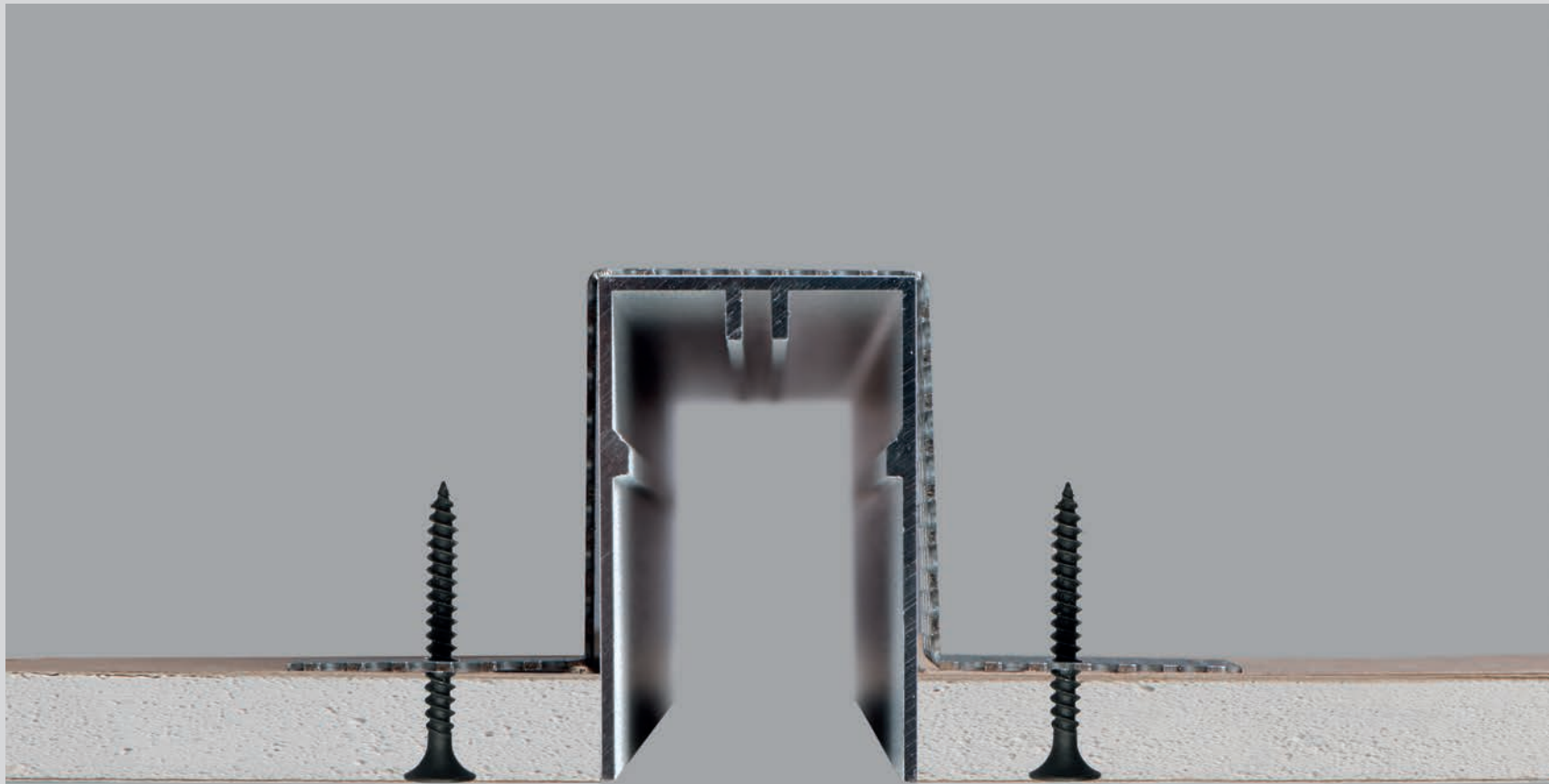

FUSION

INCASSO CON BORDO
RECESSED SYSTEM WITH TRIM

CORPO IN ALLUMINIO ESTRUSO (Bianco satinato)
EXTRUDED ALUMINIUM BAR (Frosted White)

DISSIPATORE IN ALLUMINIO / ALUMINIUM HEAT-SINK

BIADESIVO TERMICO / DOUBLE-SIDED THERMAL ADHESIVE TAPE

MODULO LED / LED MODULE

DIFFUSORE IN POLICARBONATO (A richiesta può essere sostituito con lente fascio 30°)
POLYCARBONATE DIFFUSER (Replaceable on request with a 30° lens)

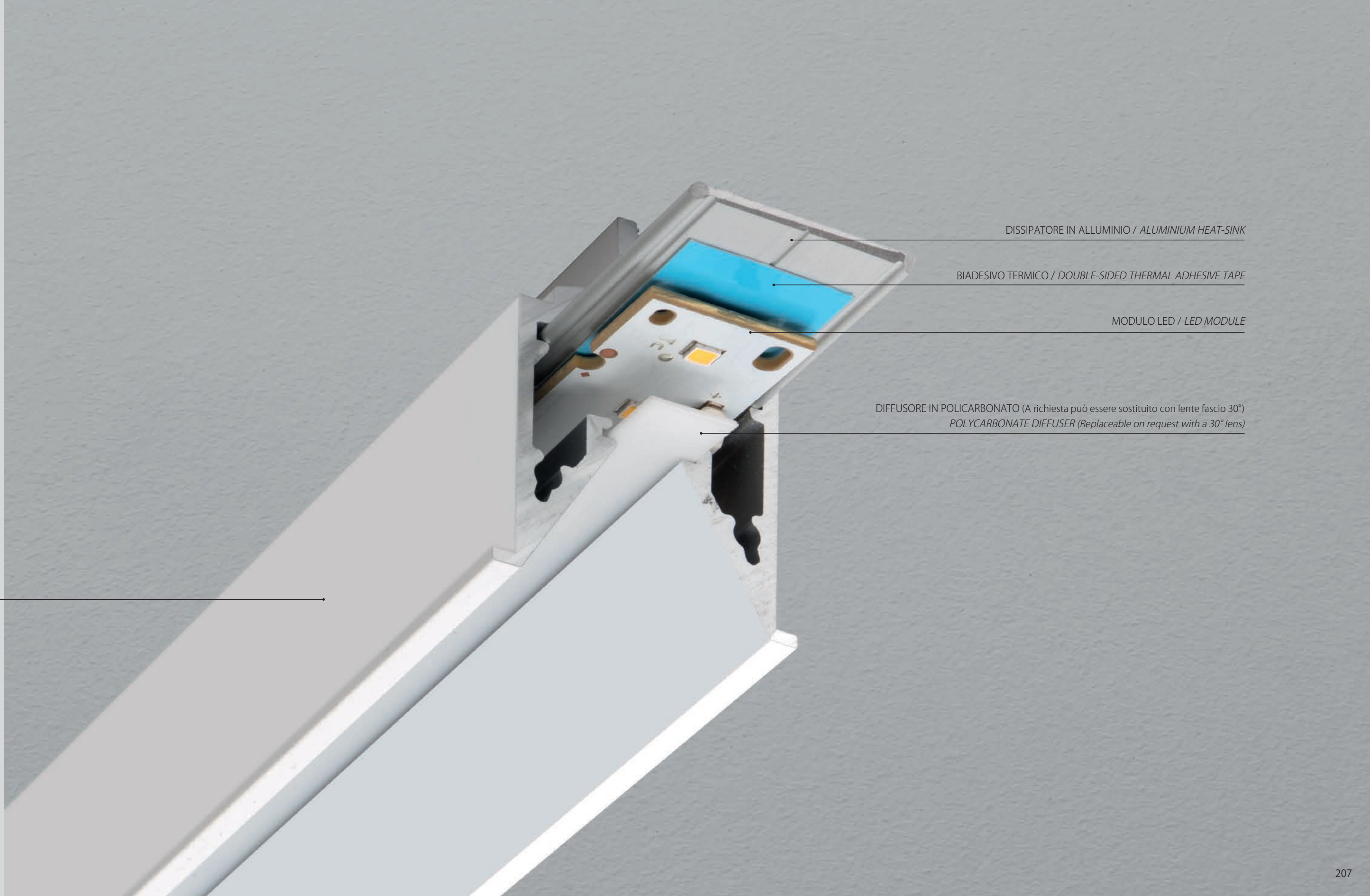

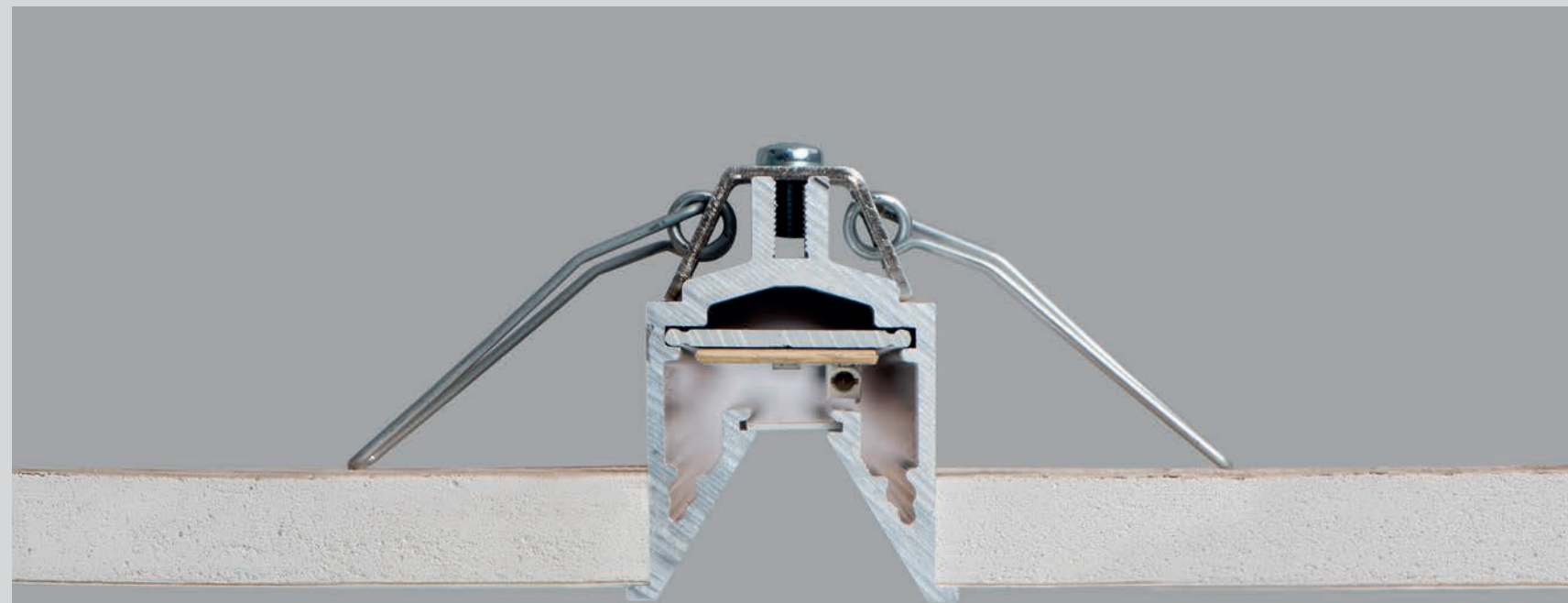
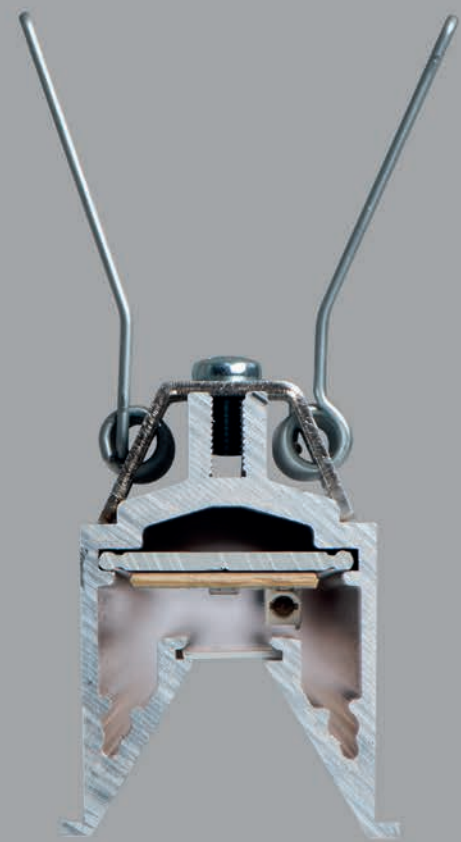

CODICE DESCRIZIONE / DESCRIPTION

ACCESSORI SISTEMA SOSPENSIONE / HANGING SYSTEM ACCESSORIES

A6-019.3	Rosone con cavo di alimentazione 3x0,75 mm ² 200 cm / Ceiling cup with supply cable 3x0,75mm ² 200 cm
A6-019.4	Rosone con cavo di alimentazione 4x0,75 mm ² 200 cm, per installazioni con doppia accensione Ceiling cup with supply cable 4x0,75mm ² 200 cm, for double switch use
A6-019.5	Rosone con cavo di alimentazione 5x0,75 mm ² 200 cm, per installazioni dimmerabili o in emergenza Ceiling cup with supply cable 5x0,75mm ² 200 cm, for dimming and emergency use
A6-036	Cavi di sospensione 200 cm / Suspension cables, 200 cm
A6-037	Giunto lineare / In-line connector
X	Prolungamento + 32 mm per curva 90° / Extension + 32 mm for a 90° corner
Y	Prolungamento + 32 mm per curva 90° / Extension + 32 mm for a 90° corner
Z	Prolungamento + 32 mm per curva 90° / Extension + 32 mm for a 90° corner
K	Prolungamento + 32 mm per curva 90° / Extension + 32 mm for a 90° corner
W	Prolungamento + 32 mm per curva 90° / Extension + 32 mm for a 90° corner
T	Tappo d'inizio o fine sistema (singolo) / End cap (single)
TT	Tappi per unico modulo (coppia) / End caps for one single section (pair)
LE001-30/100	Lente con fascio 30° (codice al metro) / 30° lens (code per meter)

ACCESSORI SISTEMA PLAFONE / CEILING SYSTEM ACCESSORIES

A6-037	Giunto lineare / In-line connector
X	Prolungamento + 32 mm per curva 90° / Extension + 32 mm for a 90° corner
Y	Prolungamento + 32 mm per curva 90° / Extension + 32 mm for a 90° corner
Z	Prolungamento + 32 mm per curva 90° / Extension + 32 mm for a 90° corner
K	Prolungamento + 32 mm per curva 90° / Extension + 32 mm for a 90° corner
W	Prolungamento + 32 mm per curva 90° / Extension + 32 mm for a 90° corner
T	Tappo d'inizio o fine sistema (singolo) / End cap (single)
TT	Tappi per unico modulo (coppia) / End caps for one single section (pair)
LE001-30/100	Lente con fascio 30° (codice al metro) / 30° lens (code per meter)

ACCESSORI SISTEMA INCASSO CON BORDO / RECESSED SYSTEM WITH TRIM ACCESSORIES

A6-037	Giunto lineare / In-line connector
A6-038	Terminale di chiusura (coppia) / End caps (pair)
X	Prolungamento + 37 mm per curva 90° / Extension + 37 mm for a 90° corner
Y	Prolungamento + 37 mm per curva 90° / Extension + 37 mm for a 90° corner
Z	Prolungamento + 37 mm per curva 90° / Extension + 37 mm for a 90° corner
K	Prolungamento + 37 mm per curva 90° / Extension + 37 mm for a 90° corner
W	Prolungamento + 37 mm per curva 90° / Extension + 37 mm for a 90° corner
LE001-30/100	Lente con fascio 30° (codice al metro) / 30° lens (code per meter)

ACCESSORI SISTEMA INCASSO SENZA BORDO / TRIMLESS RECESSED SYSTEM ACCESSORIES

A6-037	Giunto lineare / In-line connector
A6-039	Terminali di chiusura (coppia) / End caps (pair)
A6-040	Terminali di chiusura per cassaforma (coppia) / End caps for flush box (pair)
X	Prolungamento + 32 mm per curva 90° / Extension + 32 mm for a 90° corner
Y	Prolungamento + 32 mm per curva 90° / Extension + 32 mm for a 90° corner
Z	Prolungamento + 32 mm per curva 90° / Extension + 32 mm for a 90° corner
K	Prolungamento + 32 mm per curva 90° / Extension + 32 mm for a 90° corner
W	Prolungamento + 32 mm per curva 90° / Extension + 32 mm for a 90° corner
LE001-30/100	Lente con fascio 30° (codice al metro) / 30° lens (code per meter)
0800/DIM	Dispositivo di dimmerazione (DIMMER) / Dimming kit
0800/EM	Kit di emergenza con pacco batterie / Emergency kit with batteries

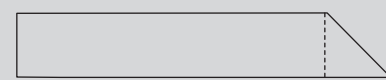

Cod. X

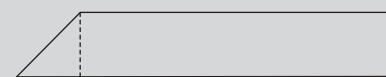

Cod. Y

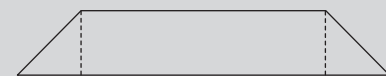

Cod. Z



Cod. K

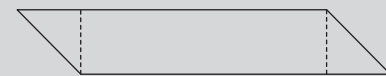

Cod. W

A richiesta altre tipologie di curva
Customized corner on request

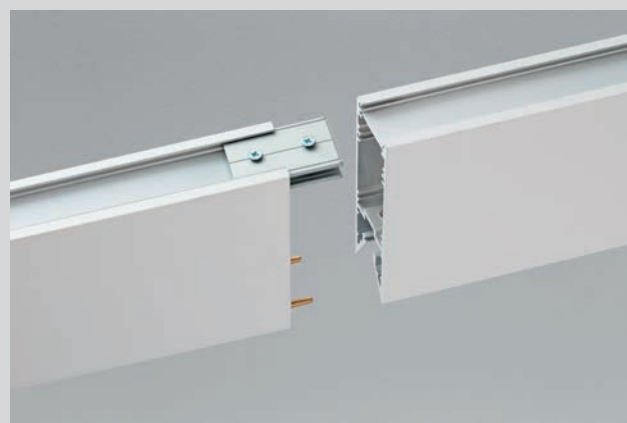

Giunto lineare / In-line connector

FUSION

ACCESSORI / ACCESSORIES

Lente di fascio 30° che, riducendo la luminanza diretta dell'apparecchio, rende Fusion adatto all'installazione in ambienti in cui viene richiesto un UGR<19 (normativa UNI-11165 e UNI 12464-1), quali uffici o postazioni con videotermini.

The 30° lens reducing the luminaire's direct lighting permits Fusion to be used in spaces requiring an excellent visual comfort (UGR<19, standards UNI-11165 and EN 12464-1), like offices and workstations with video terminals.





LINE

SISTEMA SOSPENSIONE / HANGING SYSTEM

La massima rigosità delle linee definisce Line, un sistema componibile a sospensione eccellente negli ambienti in cui è richiesta una fonte di luce diretta. Commissionabile in lunghezze su misura, è realizzato in alluminio estruso verniciato a polvere epossipoliestere con diffusore in policarbonato opalino o, a richiesta, in polimetilmetacrilato microprismato (UGR<19, norma UNI-11165 e EN 12464-1). Line è fornito di sorgente a LED ad alta efficienza, driver e cablaggio a quattro conduttori passanti per due circuiti elettrici con neutro in comune. L'installazione a sospensione avviene mediante l'utilizzo di cavetti di acciaio zincato (non inclusi), dotati di dispositivi a regolazione rapida. Per ottenere maggiore adattabilità è disponibile una vasta scelta di accessori. Richiedibile nelle versioni emergenza tipo SA, autonomia 1h e dimmerabile DALI/switch-dim. Il grado di protezione contro la penetrazione di polvere, corpi solidi e liquidi è IP40.

A modular hanging lamp for direct lighting with a stark design. Line is made from epoxy polyester powder coated aluminium and it is equipped with an opal polycarbonate diffuser, high efficiency LED modules and driver. The lamp is suspended with galvanized steel cables (not included) with quick-adjust regulation devices. A wide range of accessories is available to customize the system. This product includes wiring with four wires that pass through two electrical circuits with shared neutral. Micro-prismatic polymethyl methacrylate screen reducing the luminaire's direct lighting (UGR<19, standards UNI-11165 and EN 12464-1), SA emergency version (1 hour of autonomy) and switch-dim/DALI dimmable version available on request. Its degree of protection against the penetration of dust, solid objects and liquids is IP40.

LINE PRO

CODICE	W	Lm (3000K)
A6-604P.084...	36	4500
A6-604P.112...	48	6000
A6-604P.140...	60	7500
A6-604P.168...	72	9000
A6-604P.196...	84	10500
A6-604P.224...	96	12000
A6-604P.252...	108	13500
A6-604P.280...	120	15000
A6-015/100*	Diffusore in polimetilmetacrilato microprismato <i>Micro-prismatic polymethyl methacrylate screen</i>	

/DIMM2 dimmerabile protocollo DALI

/DIMM3 dimmerabile switch-DIM

/EM modulo in emergenza

*codice al metro / *code per meter

accessori esclusi p. 236 / accessories not included p. 236

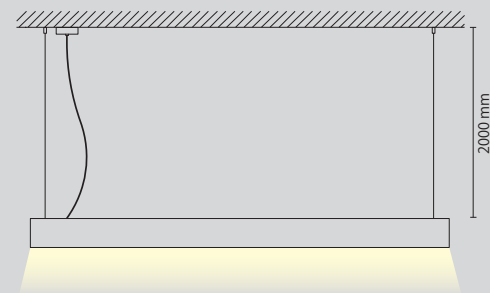

mm	codice	Kg
845*	A6-604P.084	1,8
1125*	A6-604P.112	2,3
1405*	A6-604P.140	2,8
1685*	A6-604P.168	3,3
1965*	A6-604P.196	4,1
2245*	A6-604P.224	4,5
2525*	A6-604P.252	5,1
2805*	A6-604P.280	5,6

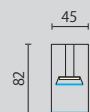

***ATTENZIONE:** aggiungere ad inizio e fine sistema 2,5 mm di spessore per i tappi di chiusura.

***NOTICE:** add a 2,5 mm thickness for the end caps to the beginning and the end of the system.

LINE PRO LIGHT

CODICE	W	Lm (3000K)
A6-604PL.084...	27	3300
A6-604PL.112...	35	4400
A6-604PL.140...	44	5500
A6-604PL.168...	53	6600
A6-604PL.196...	62	7700
A6-604PL.224...	71	8800
A6-604PL.252...	80	9900
A6-604PL.280...	88	11000
A6-015/100*	Diffusore in polimetilmetacrilato microprismato <i>Micro-prismatic polymethyl methacrylate screen</i>	

/DIMM2 dimmerabile protocollo DALI

/DIMM3 dimmerabile switch-DIM

/EM modulo in emergenza

*codice al metro / *code per meter

accessori esclusi p. 236 / accessories not included p. 236

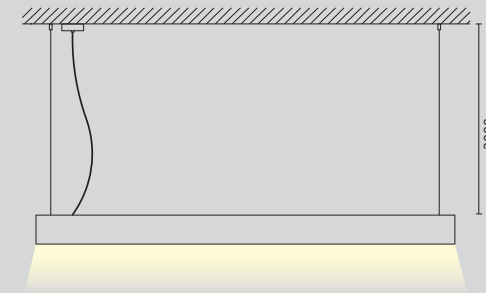

mm	codice	Kg
845*	A6-604PL.084	1,8
1125*	A6-604PL.112	2,3
1405*	A6-604PL.140	2,8
1685*	A6-604PL.168	3,3
1965*	A6-604PL.196	4,1
2245*	A6-604PL.224	4,5
2525*	A6-604PL.252	5,1
2805*	A6-604PL.280	5,7

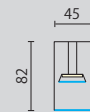

***ATTENZIONE:** aggiungere ad inizio e fine sistema 2,5 mm di spessore per i tappi di chiusura.

***NOTICE:** add a 2,5 mm thickness for the end caps to the beginning and the end of the system.

LINE SOFT

CODICE	W	Lm (3000K)
A6-604S.084...	18	2430
A6-604S.112...	24	3250
A6-604S.140...	30	4060
A6-604S.168...	36	4870
A6-604S.196...	42	5680
A6-604S.224...	48	6500
A6-604S.252...	54	7310
A6-604S.280...	60	8120
A6-015/100*	Diffusore in polimetilmetacrilato microprismato <i>Micro-prismatic polymethyl methacrylate screen</i>	

/DIMM2 dimmerabile protocollo DALI

/DIMM3 dimmerabile switch-DIM

/EM modulo in emergenza

*codice al metro / *code per meter

accessori esclusi p. 236 / accessories not included p. 236

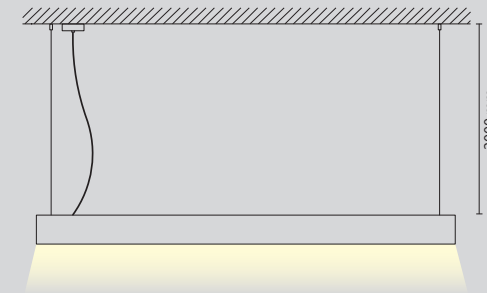

mm	codice	Kg
845*	A6-604S.084	1,8
1125*	A6-604S.112	2,3
1405*	A6-604S.140	2,8
1685*	A6-604S.168	3,3
1965*	A6-604S.196	4,1
2245*	A6-604S.224	4,5
2525*	A6-604S.252	5,1
2805*	A6-604S.280	5,6

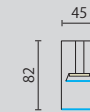

***ATTENZIONE:** aggiungere ad inizio e fine sistema 2,5 mm di spessore per i tappi di chiusura.

***NOTICE:** add a 2,5 mm thickness for the end caps to the beginning and the end of the system.

	105°
TC	3000K / 4000K
IP	40
CRI	>80
EEL	A++
RG	0
02	Nero opaco
09	Bianco opaco



Line con diffusore in polimetilmetacrilato microprismato
Line with micro-prismatic polymethyl methacrylate screen

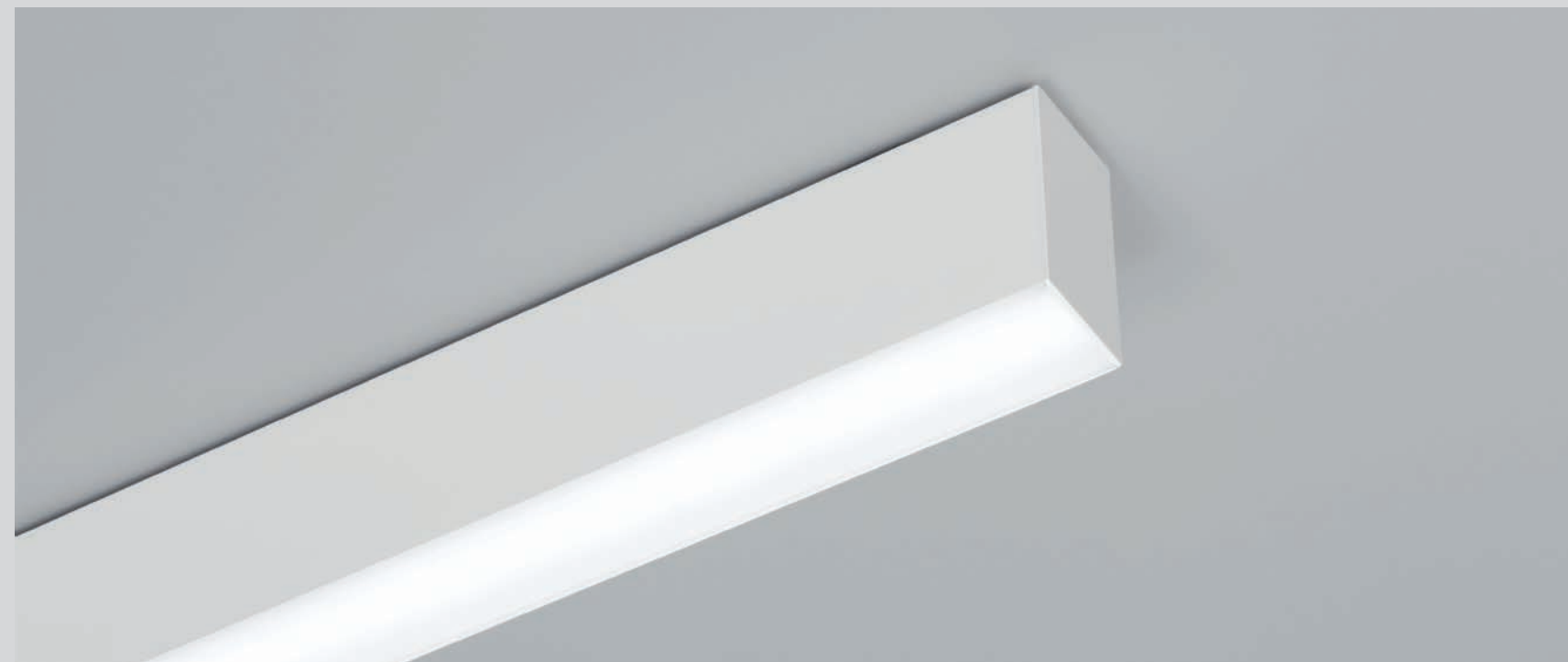

LINE

SISTEMA PLAFONE / CEILING SYSTEM

Profilo progettato per valorizzare la luce e creare passaggi luminosi che si susseguono del tutto privi di zone buie, Line è un apparecchio componibile a plafone commissionabile in lunghezze su misura. Realizzato in alluminio estruso verniciato a polvere epossipoliestere con diffusore in policarbonato opalino o, a richiesta, in polimetilmetacrilato microprismato, Line è fornito di sorgente a LED ad alta efficienza, driver e cablaggio a quattro conduttori passanti per due circuiti elettrici con neutro in comune. L'installazione a plafone avviene mediante l'utilizzo di accessori in acciaio zincato inclusi. Per ottenere maggiore adattabilità è disponibile una vasta scelta di accessori. Richiedibile nelle versioni emergenza tipo SA, autonomia 1h e dimmerabile DALI/switch-dim. Il grado di protezione contro la penetrazione di polvere, corpi solidi e liquidi è IP40.

Conceived for enhancing the light, Line is a modular single emission ceiling lamp made from epoxy polyester powder coated aluminium and it is equipped with an opal polycarbonate diffuser, high efficiency LED modules and driver. The lamp is suspended with galvanized steel cables (not included) with quick-adjust regulation devices. A wide range of accessories is available to customize the system. This product includes wiring with four wires that pass through two electrical circuits with shared neutral. Micro-prismatic polymethyl methacrylate screen reducing the luminaire's direct lighting (UGR<19, standards UNI-11165 and EN 12464-1), SA emergency version (1 hour of autonomy) and switch-dim/DALI dimmable version available on request. Its degree of protection against the penetration of dust, solid objects and liquids is IP40.

LINE PRO

CODICE	W	Lm (3000K)
A6-614P.084...	36	4500
A6-614P.112...	48	6000
A6-614P.140...	60	7500
A6-614P.168...	72	9000
A6-614P.196...	84	10500
A6-614P.224...	96	12000
A6-614P.252...	108	13500
A6-614P.280...	120	15000
A6-015/100*	Diffusore in polimetilmetacrilato microprismato <i>Micro-prismatic polymethyl methacrylate screen</i>	

/DIMM2 dimmerabile protocollo DALI

/DIMM3 dimmerabile switch-DIM

/EM modulo in emergenza

*codice al metro / *code per meter

accessori esclusi p. 236 / accessories not included p. 236

LINE PRO LIGHT

CODICE	W	Lm (3000K)
A6-614PL.084...	27	3300
A6-614PL.112...	35	4400
A6-614PL.140...	44	5500
A6-614PL.168...	53	6600
A6-614PL.196...	62	7700
A6-614PL.224...	71	8800
A6-614PL.252...	80	9900
A6-614PL.280...	88	11000
A6-015/100*	Diffusore in polimetilmetacrilato microprismato <i>Micro-prismatic polymethyl methacrylate screen</i>	

/DIMM2 dimmerabile protocollo DALI

/DIMM3 dimmerabile switch-DIM

/EM modulo in emergenza

*codice al metro / *code per meter

accessori esclusi p. 236 / accessories not included p. 236

LINE SOFT

CODICE	W	Lm (3000K)
A6-614S.084...	18	2430
A6-614S.112...	24	3250
A6-614S.140...	30	4060
A6-614S.168...	36	4870
A6-614S.196...	42	5680
A6-614S.224...	48	6500
A6-614S.252...	54	7310
A6-614S.280...	60	8120
A6-015/100*	Diffusore in polimetilmetacrilato microprismato <i>Micro-prismatic polymethyl methacrylate screen</i>	

/DIMM2 dimmerabile protocollo DALI

/DIMM3 dimmerabile switch-DIM

/EM modulo in emergenza

*codice al metro / *code per meter

accessori esclusi p. 236 / accessories not included p. 236

	105°
TC	3000K / 4000K
IP	40
CRI	>80
EEL	A++
RG	0
02	Nero opaco
09	Bianco opaco

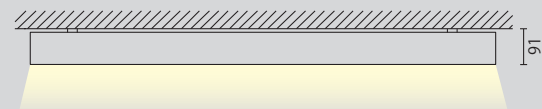

mm	code	Kg
845*	A6-614P.084	1,8
1125*	A6-614P.112	2,3
1405*	A6-614P.140	2,8
1685*	A6-614P.168	3,3
1965*	A6-614P.196	4,1
2245*	A6-614P.224	4,5
2525*	A6-614P.252	5,1
2805*	A6-614P.280	5,6



***ATTENZIONE:** aggiungere ad inizio e fine sistema 2,5 mm di spessore per i tappi di chiusura.

***NOTICE:** add a 2,5 mm thickness for the end caps to the beginning and the end of the system.

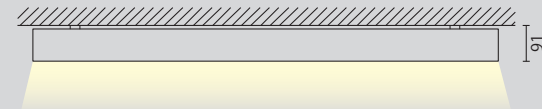

mm	codice	Kg
845*	A6-614PL.084	1,8
1125*	A6-614PL.112	2,3
1405*	A6-614PL.140	2,8
1685*	A6-614PL.168	3,3
1965*	A6-614PL.196	4,1
2245*	A6-614PL.224	4,5
2525*	A6-614PL.252	5,1
2805*	A6-614PL.280	5,6

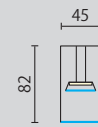

***ATTENZIONE:** aggiungere ad inizio e fine sistema 2,5 mm di spessore per i tappi di chiusura.

***NOTICE:** add a 2,5 mm thickness for the end caps to the beginning and the end of the system.

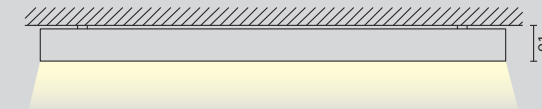

mm	codice	Kg
845*	A6-614S.084	1,8
1125*	A6-614S.112	2,3
1405*	A6-614S.140	2,8
1685*	A6-614S.168	3,3
1965*	A6-614S.196	4,1
2245*	A6-614S.224	4,5
2525*	A6-614S.252	5,1
2805*	A6-614S.280	5,6

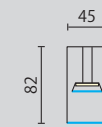

***ATTENZIONE:** aggiungere ad inizio e fine sistema 2,5 mm di spessore per i tappi di chiusura.

***NOTICE:** add a 2,5 mm thickness for the end caps to the beginning and the end of the system.

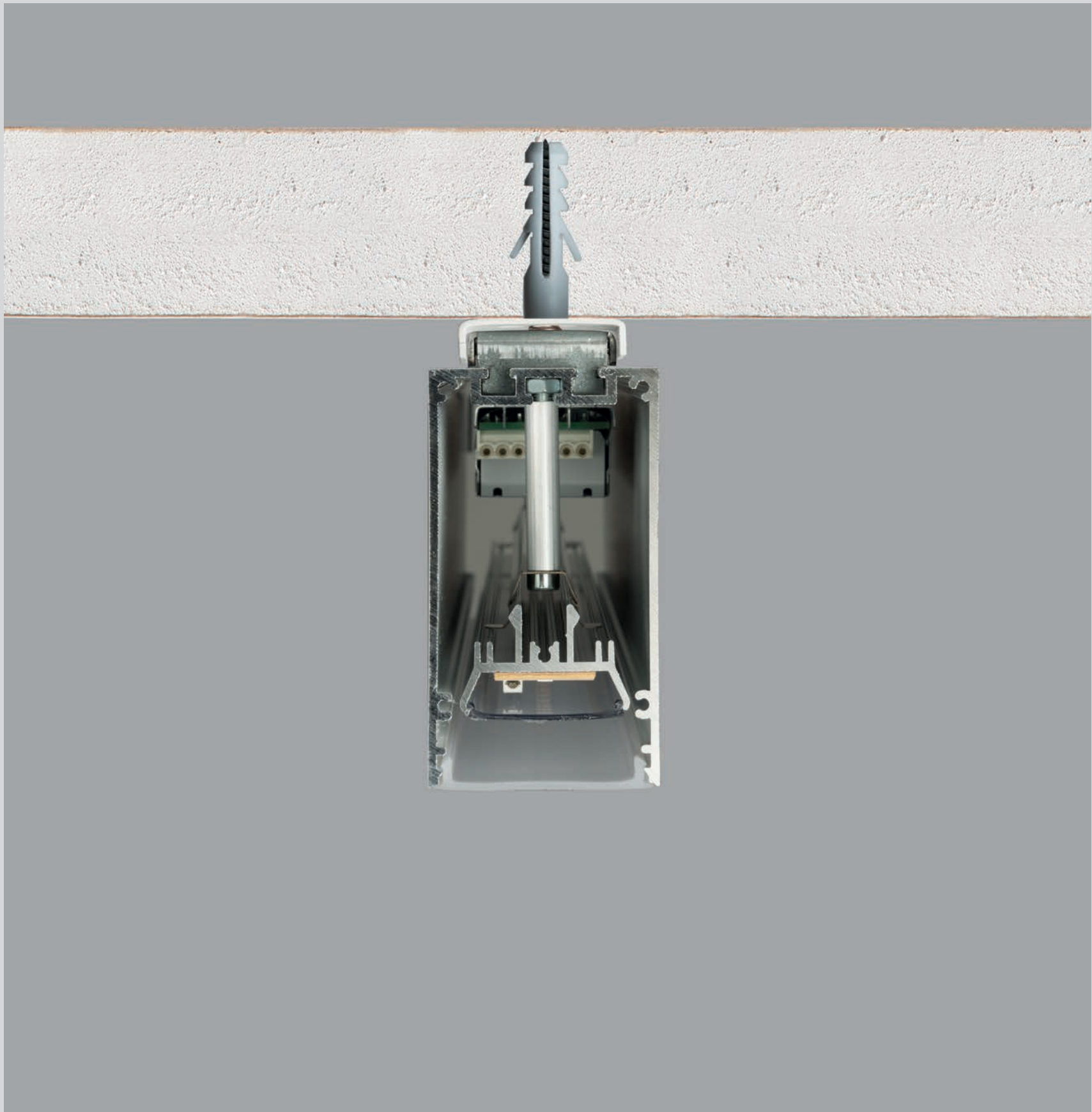





Showroom ceramiche Zaninoni, Bernareggio (MB)

LINE PRO CON BORDO / WITH TRIM

CODICE	W	Lm (3000K)
A6-624P.084...	36	4500
A6-624P.112...	48	6000
A6-624P.140...	60	7500
A6-624P.168...	72	9000
A6-624P.196...	84	10500
A6-624P.224...	96	12000
A6-624P.252...	108	13500
A6-624P.280...	120	15000
A6-015/100*	Diffusore in polimetilmetacrilato microprismato <i>Micro-prismatic polymethyl methacrylate screen</i>	

/DIMM2 dimmerabile protocollo DALI

/DIMM3 dimmerabile switch-DIM

/EM modulo in emergenza

*codice al metro / *code per meter

accessori esclusi p. 236 / accessories not included p. 236

LINE PRO LIGHT CON BORDO / WITH TRIM

CODICE	W	Lm (3000K)
A6-624PL.084...	27	3300
A6-624PL.112...	35	4400
A6-624PL.140...	44	5500
A6-624PL.168...	53	6600
A6-624PL.196...	62	7700
A6-624PL.224...	71	8800
A6-624PL.252...	80	9900
A6-624PL.280...	88	11000
A6-015/100*	Diffusore in polimetilmetacrilato microprismato <i>Micro-prismatic polymethyl methacrylate screen</i>	

/DIMM2 dimmerabile protocollo DALI

/DIMM3 dimmerabile switch-DIM

/EM modulo in emergenza

*codice al metro / *code per meter

accessori esclusi p. 236 / accessories not included p. 236

LINE SOFT CON BORDO / WITH TRIM

CODICE	W	Lm (3000K)
A6-624S.084...	18	2430
A6-624S.112...	24	3250
A6-624S.140...	30	4060
A6-624S.168...	36	4870
A6-624S.196...	42	5680
A6-624S.224...	48	6500
A6-624S.252...	54	7310
A6-624S.280...	60	8120
A6-015/100*	Diffusore in polimetilmetacrilato microprismato <i>Micro-prismatic polymethyl methacrylate screen</i>	







/DIMM2 dimmerabile protocollo DALI

/DIMM3 dimmerabile switch-DIM

/EM modulo in emergenza

*codice al metro / *code per meter

accessori esclusi p. 236 / accessories not included p. 236

	105°
	3000K / 4000K
	40
	>80
	A++
	0
	Bianco opaco

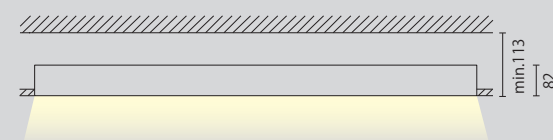

mm	codice	Kg
845*	A6-624P.084	1,8
1125*	A6-624P.112	2,3
1405*	A6-624P.140	2,8
1685*	A6-624P.168	3,3
1965*	A6-624P.196	4,1
2245*	A6-624P.224	4,5
2525*	A6-624P.252	5,1
2805*	A6-624P.280	5,6

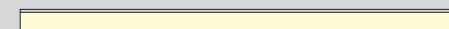

***ATTENZIONE:** aggiungere ad inizio e fine sistema 10 mm di spessore per i tappi di chiusura.

***NOTICE:** add a 10 mm thickness for the end caps to the beginning and the end of the system.

larghezza: 50 mm
lunghezza: sottrarre 14 mm dalla lunghezza totale della composizione.

width: 50 mm
length: subtract 14 mm from the total length of the composition.

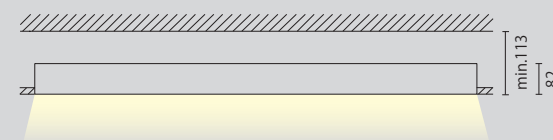

mm	codice	Kg
845*	A6-624PL.084	1,8
1125*	A6-624PL.112	2,3
1405*	A6-624PL.140	2,8
1685*	A6-624PL.168	3,3
1965*	A6-624PL.196	4,1
2245*	A6-624PL.224	4,5
2525*	A6-624PL.252	5,1
2805*	A6-624PL.280	5,6

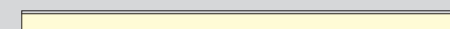

***ATTENZIONE:** aggiungere ad inizio e fine sistema 10 mm di spessore per i tappi di chiusura.

***NOTICE:** add a 10 mm thickness for the end caps to the beginning and the end of the system.

larghezza: 50 mm
lunghezza: sottrarre 14 mm dalla lunghezza totale della composizione.

width: 50 mm
length: subtract 14 mm from the total length of the composition.

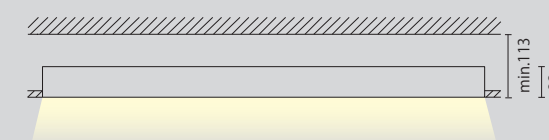

mm	codice	Kg
845*	A6-624S.084	1,8
1125*	A6-624S.112	2,3
1405*	A6-624S.140	2,8
1685*	A6-624S.168	3,3
1965*	A6-624S.196	4,1
2245*	A6-624S.224	4,5
2525*	A6-624S.252	5,1
2805*	A6-624S.280	5,6

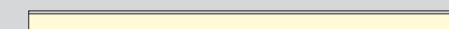

***ATTENZIONE:** aggiungere ad inizio e fine sistema 10 mm di spessore per i tappi di chiusura.

***NOTICE:** add a 10 mm thickness for the end caps to the beginning and the end of the system.

larghezza: 50 mm
lunghezza: sottrarre 14 mm dalla lunghezza totale della composizione.

width: 50 mm
length: subtract 14 mm from the total length of the composition.

LINE

SISTEMA INCASSO CON BORDO / RECESSED SYSTEM WITH TRIM

Line è un apparecchio componibile a incasso disponibile con o senza bordo, commissionabile in lunghezze su misura e in grado di aggiungere valore allo spazio attraverso la leggerezza formale. Realizzato in alluminio estruso verniciato a polvere epossipoliestere con diffusore in policarbonato opalino o, a richiesta, in polimetilmetacrilato microprismato (UGR<19, norma UNI-11165 e EN 12464-1), Line è fornito di sorgente a LED ad alta efficienza, driver e cablaggio a quattro conduttori passanti per due circuiti elettrici con neutro in comune. Per ottenere maggiore adattabilità è disponibile una vasta scelta di accessori. Richiedibile nelle versioni emergenza tipo SA, autonomia 1h e dimmerabile DALI/switch-dim. Il grado di protezione contro la penetrazione di polvere, corpi solidi e liquidi è IP40.

Line is a modular single emission recessed lamp made from epoxy polyester powder coated aluminium and it is equipped with an opal polycarbonate diffuser, high efficiency LED modules and driver. A wide range of accessories is available to customize the system. This product includes wiring with four wires that pass through two electrical circuits with shared neutral. Micro-prismatic polymethyl methacrylate screen reducing the luminaire's direct lighting (UGR<19, standards UNI-11165 and EN 12464-1), SA emergency version (1 hour of autonomy) and switch-dim/DALI dimmable version available on request. Its degree of protection against the penetration of dust, solid objects and liquids is IP40.

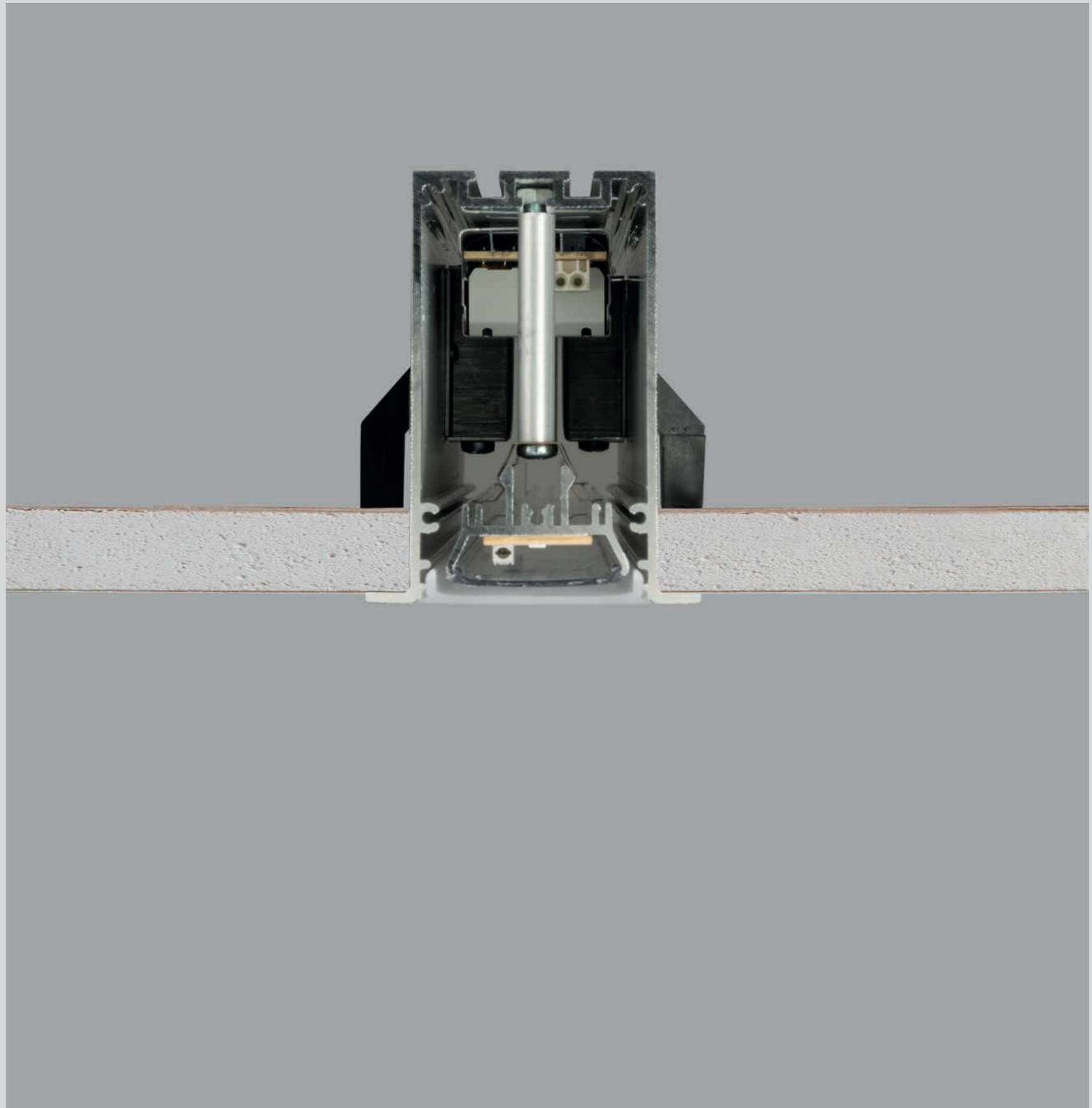
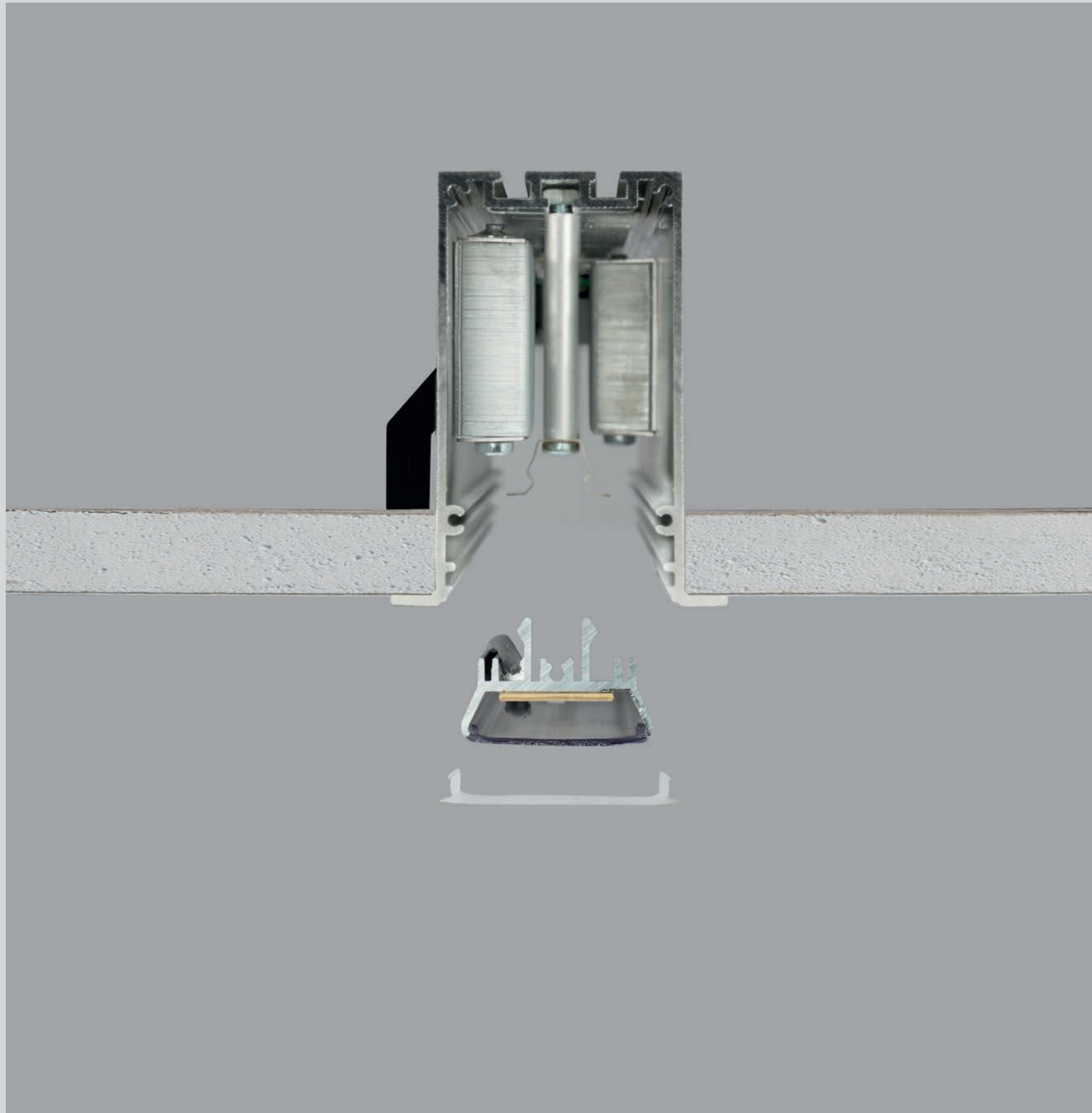



Showroom ceramiche Zaninoni, Bernareggio (MB)

	105°
TC	3000K / 4000K
IP	40
CRI	>80
EEI	A++
RG	0
09	Bianco opaco

LINE

SISTEMA INCASSO SENZA BORDO / TRIMLESS RECESSED SYSTEM

Line è un apparecchio componibile a incasso disponibile con o senza bordo, commissionabile in lunghezze su misura e in grado di aggiungere valore allo spazio attraverso la leggerezza formale. Realizzato in alluminio estruso verniciato a polvere epossipoliestere con diffusore in policarbonato opalino o, a richiesta, in polimetilmetacrilato microprismato (UGR<19, norma UNI-11165 e EN 12464-1), Line è fornito di sorgente a LED ad alta efficienza, driver e cablaggio a quattro conduttori passanti per due circuiti elettrici con neutro in comune. L'installazione avviene mediante l'utilizzo di accessori in acciaio zincato inclusi. Per ottenere maggiore adattabilità è disponibile una vasta scelta di accessori. Richiedibile nelle versioni emergenza tipo SA, autonomia 1h e dimmerabile DALI/switch-dim. Il grado di protezione contro la penetrazione di polvere, corpi solidi e liquidi è IP40.

Line is a modular single emission recessed lamp made from epoxy polyester powder coated aluminium and it is equipped with an opal polycarbonate diffuser, high efficiency LED modules and driver. A wide range of accessories is available to customize the system. This product includes wiring with four wires that pass through two electrical circuits with shared neutral. Micro-prismatic polymethyl methacrylate screen reducing the luminaire's direct lighting (UGR<19, standards UNI-11165 and EN 12464-1), SA emergency version (1 hour of autonomy) and switch-dim/DALI dimmable version available on request. Its degree of protection against the penetration of dust, solid objects and liquids is IP40.

LINE PRO SENZA BORDO / TRIMLESS

CODICE	W	Lm (3000K)
A6-626P.084...	36	4500
A6-626P.112...	48	6000
A6-626P.140...	60	7500
A6-626P.168...	72	9000
A6-626P.196...	84	10500
A6-626P.224...	96	12000
A6-626P.252...	108	13500
A6-626P.280...	120	15000
A6-015/100*	Diffusore in polimetilmetacrilato microprismato <i>Micro-prismatic polymethyl methacrylate screen</i>	

/DIMM2 dimmerabile protocollo DALI

/DIMM3 dimmerabile switch-DIM

/EM modulo in emergenza

*codice al metro / *code per meter

accessori esclusi p. 236 / accessories not included p. 236

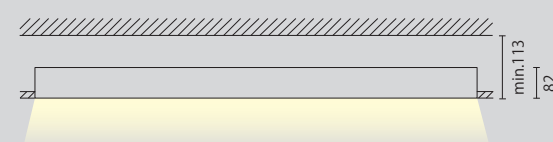

mm	codice	Kg
845*	A6-626P.084	1,8
1125*	A6-626P.112	2,3
1405*	A6-626P.140	2,8
1685*	A6-626P.168	3,3
1965*	A6-626P.196	4,1
2245*	A6-626P.224	4,5
2525*	A6-626P.252	5,1
2805*	A6-626P.280	5,6

***ATTENZIONE:** aggiungere ad inizio e fine sistema 2,5 mm di spessore per tappi di chiusura.
***NOTICE:** add a 2,5 mm thickness for the end caps to the beginning and the end of the system.

larghezza: 47 mm
lunghezza: aggiungere 9 mm alla lunghezza totale della composizione.

width: 47 mm
length: add 9 mm to the total length of the composition.

LINE PRO LIGHT SENZA BORDO / TRIMLESS

CODICE	W	Lm (3000K)
A6-626PL.084...	27	3300
A6-626PL.112...	35	4400
A6-626PL.140...	44	5500
A6-626PL.168...	53	6600
A6-626PL.196...	62	7700
A6-626PL.224...	71	8800
A6-626PL.252...	80	9900
A6-626PL.280...	88	11000
A6-015/100*	Diffusore in polimetilmetacrilato microprismato <i>Micro-prismatic polymethyl methacrylate screen</i>	

/DIMM2 dimmerabile protocollo DALI

/DIMM3 dimmerabile switch-DIM

/EM modulo in emergenza

*codice al metro / *code per meter

accessori esclusi p. 236 / accessories not included p. 236

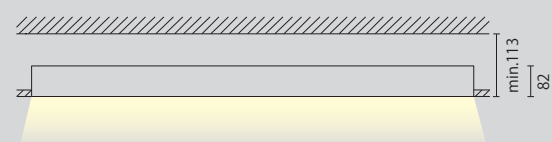

mm	codice	Kg
845*	A6-626PL.084	1,8
1125*	A6-626PL.112	2,3
1405*	A6-626PL.140	2,8
1685*	A6-626PL.168	3,3
1965*	A6-626PL.196	4,1
2245*	A6-626PL.224	4,5
2525*	A6-626PL.252	5,1
2805*	A6-626PL.280	5,6

***ATTENZIONE:** aggiungere ad inizio e fine sistema 2,5 mm di spessore per tappi di chiusura.
***NOTICE:** add a 2,5 mm thickness for the end caps to the beginning and the end of the system.

larghezza: 47 mm
lunghezza: aggiungere 9 mm alla lunghezza totale della composizione.

width: 47 mm
length: add 9 mm to the total length of the composition.

LINE SOFT SENZA BORDO / TRIMLESS

CODICE	W	Lm (3000K)
A6-626S.084...	18	2430
A6-626S.112...	24	3250
A6-626S.140...	30	4060
A6-626S.168...	36	4870
A6-626S.196...	42	5680
A6-626S.224...	48	6500
A6-626S.252...	54	7310
A6-626S.280...	60	8120
A6-015/100*	Diffusore in polimetilmetacrilato microprismato <i>Micro-prismatic polymethyl methacrylate screen</i>	

/DIMM2 dimmerabile protocollo DALI

/DIMM3 dimmerabile switch-DIM

/EM modulo in emergenza

*codice al metro / *code per meter

accessori esclusi p. 236 / accessories not included p. 236

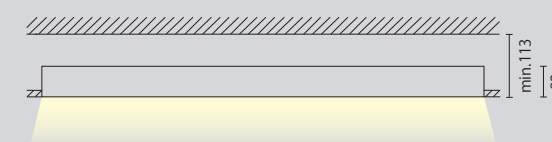

mm	codice	Kg
845*	A6-626S.084	1,8
1125*	A6-626S.112	2,3
1405*	A6-626S.140	2,8
1685*	A6-626S.168	3,3
1965*	A6-626S.196	4,1
2245*	A6-626S.224	4,5
2525*	A6-626S.252	5,1
2805*	A6-626S.280	5,6

***ATTENZIONE:** aggiungere ad inizio e fine sistema 2,5 mm di spessore per tappi di chiusura.
***NOTICE:** add a 2,5 mm thickness for the end caps to the beginning and the end of the system.

larghezza: 47 mm
lunghezza: aggiungere 9 mm alla lunghezza totale della composizione.

width: 47 mm
length: add 9 mm to the total length of the composition.

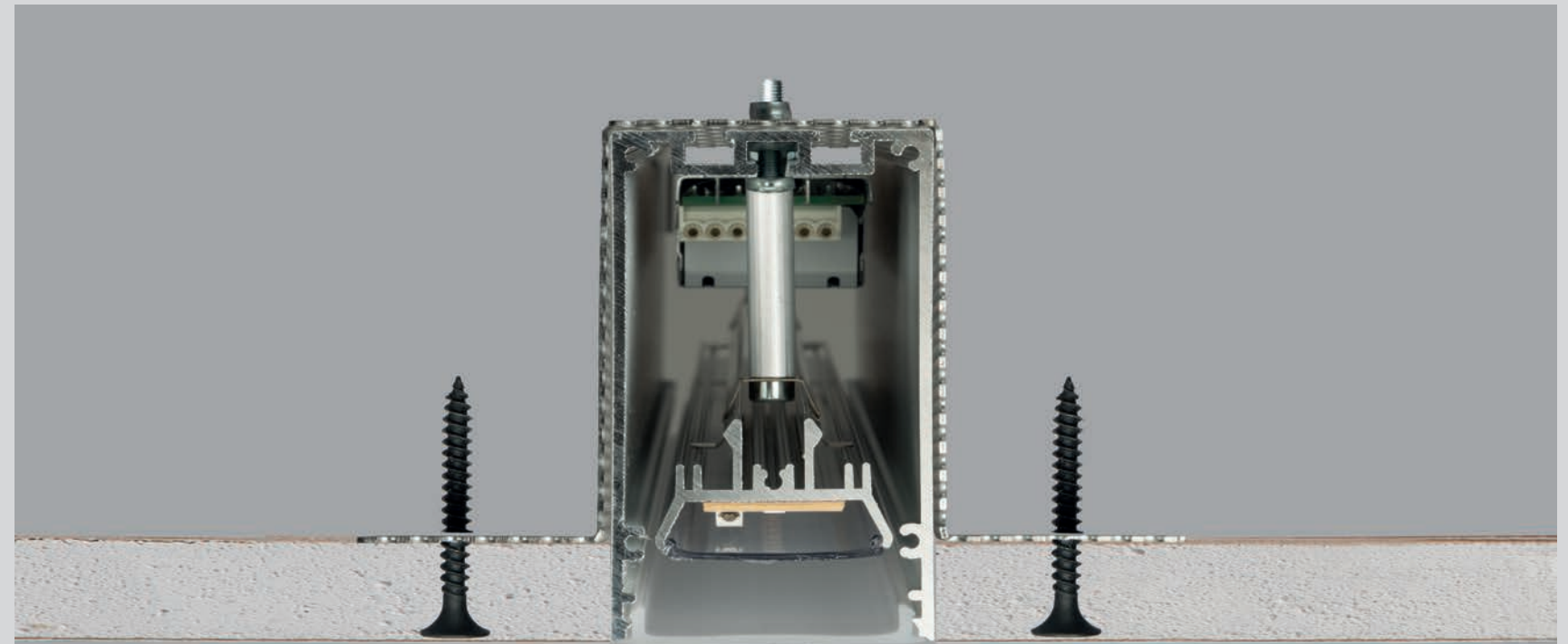
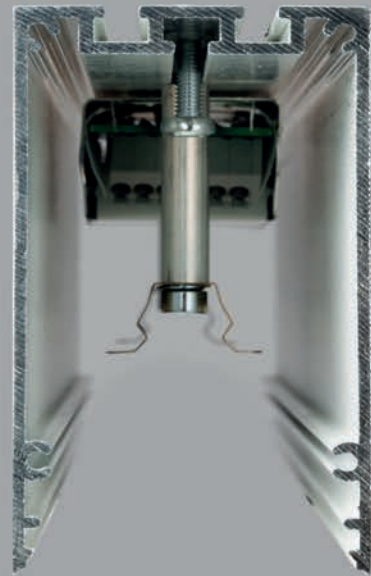
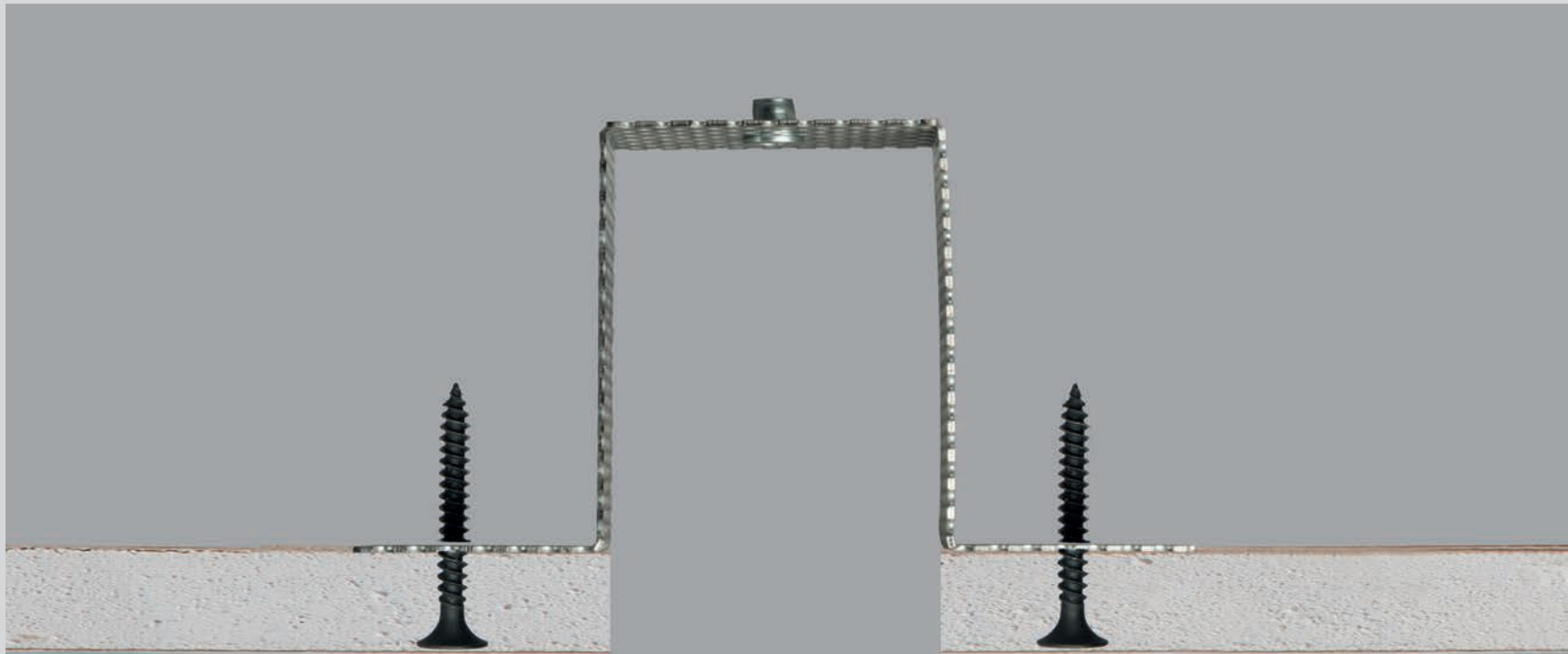

CODICE DESCRIZIONE / DESCRIPTION

ACCESSORI SISTEMA SOSPENSIONE / HANGING SYSTEM ACCESSORIES

A6-011	Terminali di chiusura (coppia). Colore 02-09 / End caps (pair). Colour 02-09
A6-019.3	Rosone con cavo di alimentazione 3x0,75 mm ² 200 cm. Colore 02-09 Ceiling cup with supply cable 3x0,75mm ² 200 cm. Colour 02-09
A6-019.4	Rosone con cavo di alimentazione 4x0,75 mm ² 200 cm, per installazioni con doppia accensione. Colore 02-09 Ceiling cup with supply cable 4x0,75mm ² 200 cm, for double switch use. Colour 02-09
A6-019.5	Rosone con cavo di alimentazione 5x0,75 mm ² 200 cm, per installazioni dimmerabili o in emergenza. Colore 02-09 Ceiling cup with supply cable 5x0,75mm ² 200 cm, for dimming and emergency use. Colour 02-09
A6-017	Cavi di sospensione 200 cm / Suspension cables, 200 cm
A6-012	Giunto lineare / In-line connector
X	Prolungamento + 45 mm per curva 90° / Extension + 45 mm for a 90° corner
Y	Prolungamento + 45 mm per curva 90° / Extension + 45 mm for a 90° corner
Z	Prolungamento + 45 mm per curva 90° / Extension + 45 mm for a 90° corner
K	Prolungamento + 45 mm per curva 90° / Extension + 45 mm for a 90° corner
W	Prolungamento + 45 mm per curva 90° / Extension + 45 mm for a 90° corner
A6-015/100	Diffusore in polimetilmetacrilato microprismato (codice al metro) Micro-prismatic polymethyl methacrylate diffuser (code per meter)

ACCESSORI SISTEMA PLAFONE / CEILING SYSTEM ACCESSORIES

A6-011	Terminali di chiusura (coppia). Colore 02-09 / End caps (pair). Colour 02-09
A6-012	Giunto lineare / In-line connector
X	Prolungamento + 45 mm per curva 90° / Extension + 45 mm for a 90° corner
Y	Prolungamento + 45 mm per curva 90° / Extension + 45 mm for a 90° corner
Z	Prolungamento + 45 mm per curva 90° / Extension + 45 mm for a 90° corner
K	Prolungamento + 45 mm per curva 90° / Extension + 45 mm for a 90° corner
W	Prolungamento + 45 mm per curva 90° / Extension + 45 mm for a 90° corner
A6-015/100	Diffusore in polimetilmetacrilato microprismato (codice al metro) Micro-prismatic polymethyl methacrylate diffuser (code per meter)

ACCESSORI SISTEMA INCASSO CON BORDO / RECESSED SYSTEM WITH TRIM ACCESSORIES

A6-021	Terminali di chiusura (coppia) / End caps (pair)
A6-012	Giunto lineare / In-line connector
X	Prolungamento + 48 mm per curva 90° / Extension + 48 mm for a 90° corner
Y	Prolungamento + 48 mm per curva 90° / Extension + 48 mm for a 90° corner
Z	Prolungamento + 48 mm per curva 90° / Extension + 48 mm for a 90° corner
K	Prolungamento + 48 mm per curva 90° / Extension + 48 mm for a 90° corner
W	Prolungamento + 48 mm per curva 90° / Extension + 48 mm for a 90° corner
A6-015/100	Diffusore in polimetilmetacrilato microprismato (codice al metro) Micro-prismatic polymethyl methacrylate diffuser (code per meter)

ACCESSORI SISTEMA INCASSO SENZA BORDO / TRIMLESS RECESSED SYSTEM ACCESSORIES

A6-011	Terminali di chiusura (coppia) / End caps (pair)
A6-012	Giunto lineare / In-line connector
X	Prolungamento + 45 mm per curva 90° / Extension + 45 mm for a 90° corner
Y	Prolungamento + 45 mm per curva 90° / Extension + 45 mm for a 90° corner
Z	Prolungamento + 45 mm per curva 90° / Extension + 45 mm for a 90° corner
K	Prolungamento + 45 mm per curva 90° / Extension + 45 mm for a 90° corner
W	Prolungamento + 45 mm per curva 90° / Extension + 45 mm for a 90° corner
A6-015/100	Diffusore in polimetilmetacrilato microprismato (codice al metro) Micro-prismatic polymethyl methacrylate diffuser (code per meter)

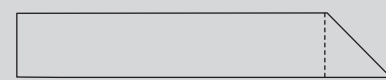

Cod. X

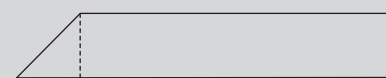

Cod. Y

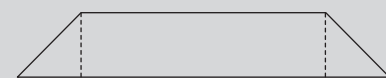

Cod. Z

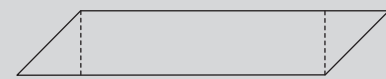

Cod. K

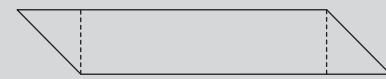

Cod. W

A richiesta altre tipologie di curva
Customized corner on request

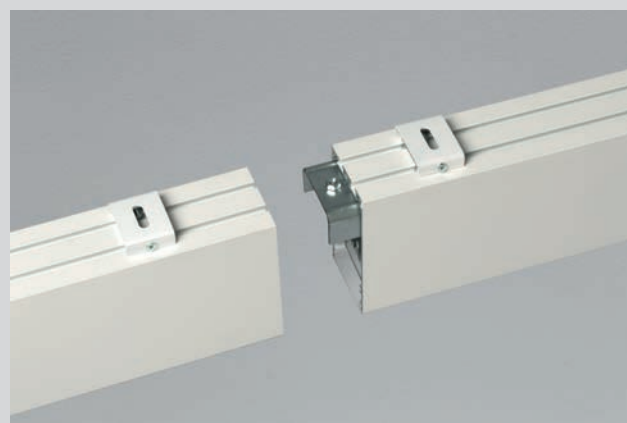

Giunto lineare / In-line connector

LINE

ACCESSORI / ACCESSORIES



Schermo in polimetilmetacrilato microprismato adatto a limitare la luminanza diretta dell'apparecchio, rendendolo idoneo per installazioni in ambienti in cui viene richiesto un indice UGR < 19 (normativa UNI -11165 e EN 12464-1): uffici e postazioni con videotermini.

The micro-prismatic polymethyl methacrylate screen reducing the luminaire's direct lighting permits Line to be used in spaces requiring an excellent visual comfort (UGR<19, standards UNI-11165 and EN 12464-1), like offices and workstations with video terminals.



Studio legale, Bergamo

MINILINE

SISTEMA INCASSO / RECESSED SYSTEM

CODICE	W	Lm (3000K)
A6-641.100...*	22	2800

*codice al metro / *code per meter
 controcassa inclusa / flush box included
 driver 24Vdc remoto, escluso p. 301 / remote driver not included p. 301
 accessori esclusi p. 244 / accessories not included p. 244

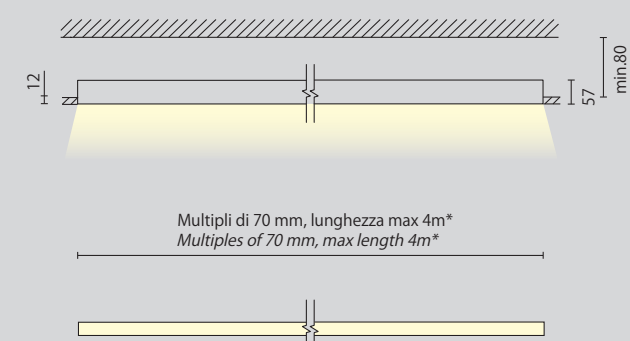

- *ATTENZIONE:** aggiungere ad inizio e fine sistema 1,2mm di spessore per tappi di chiusura.
- *NOTICE:** add a 1,2 mm thickness for the end caps to the beginning and to the end of the system.
- larghezza: 41 mm
lunghezza: aggiungere 6 mm alla lunghezza totale della composizione
- width: 41 mm
length: add 6 mm to the total length of the composition

Dimensioni ridotte, assenza di bordi e libertà compositiva rendono questo prodotto ideale per i progetti che richiedono una luce elegante e di carattere. Dotato di un sistema di aggancio rapido tramite magnete, Miniline è un apparecchio componibile da incasso commissionabile in lunghezze su misura e realizzato in alluminio estruso verniciato a polvere epossipoliestere. Fornito di diffusore in policarbonato opalino e completo di sorgente luminosa a LED ad alta efficienza, l'apparecchio necessita di driver remoto da 24Vdc (da ordinare separatamente) che, per la manutenzione, dovrà essere collocato in un vano ispezionabile posto ad una distanza non superiore a 10 metri. Il grado di protezione contro la penetrazione di polvere, corpi solidi e liquidi è IP40.

- 110°
- 3000K / 4000K
- 40
- >80
- A+
- 0
- 09 Bianco opaco

Small dimensions, trimless body and liberty of composition identify this product, which adds elegance and personality to the projects. Provided with a quick magnetic attachment system, Miniline is a modular recessed lamp made from extruded epoxy polyester powder coated aluminium and it is equipped with an opal polycarbonate diffuser and high efficiency LED modules. This fixture requires a 24Vdc remote driver (to be ordered separately) which, for maintenance purposes, must be placed in an inspection box at a distance of no more than 10 metres. Its degree of protection against the penetration of dust, solid objects and liquids is IP40.

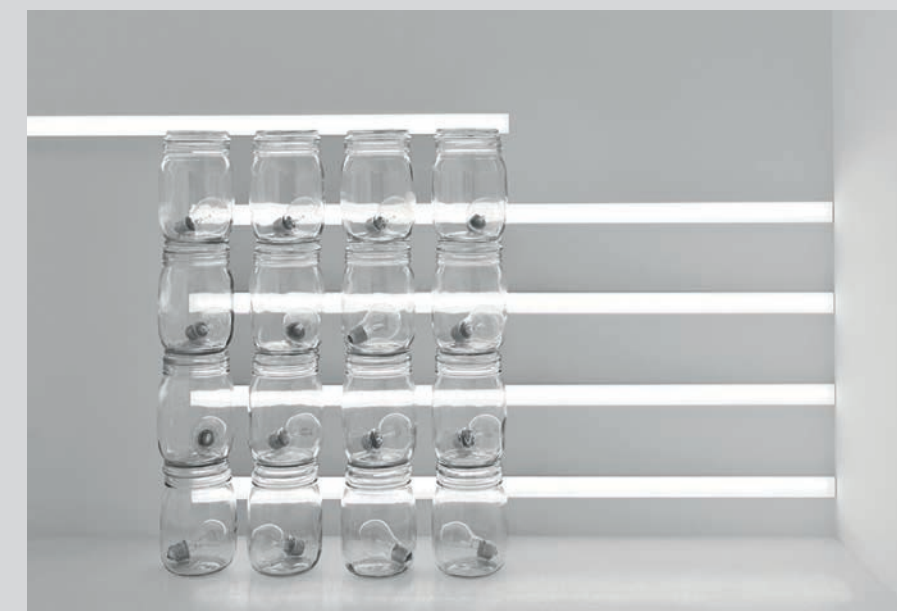



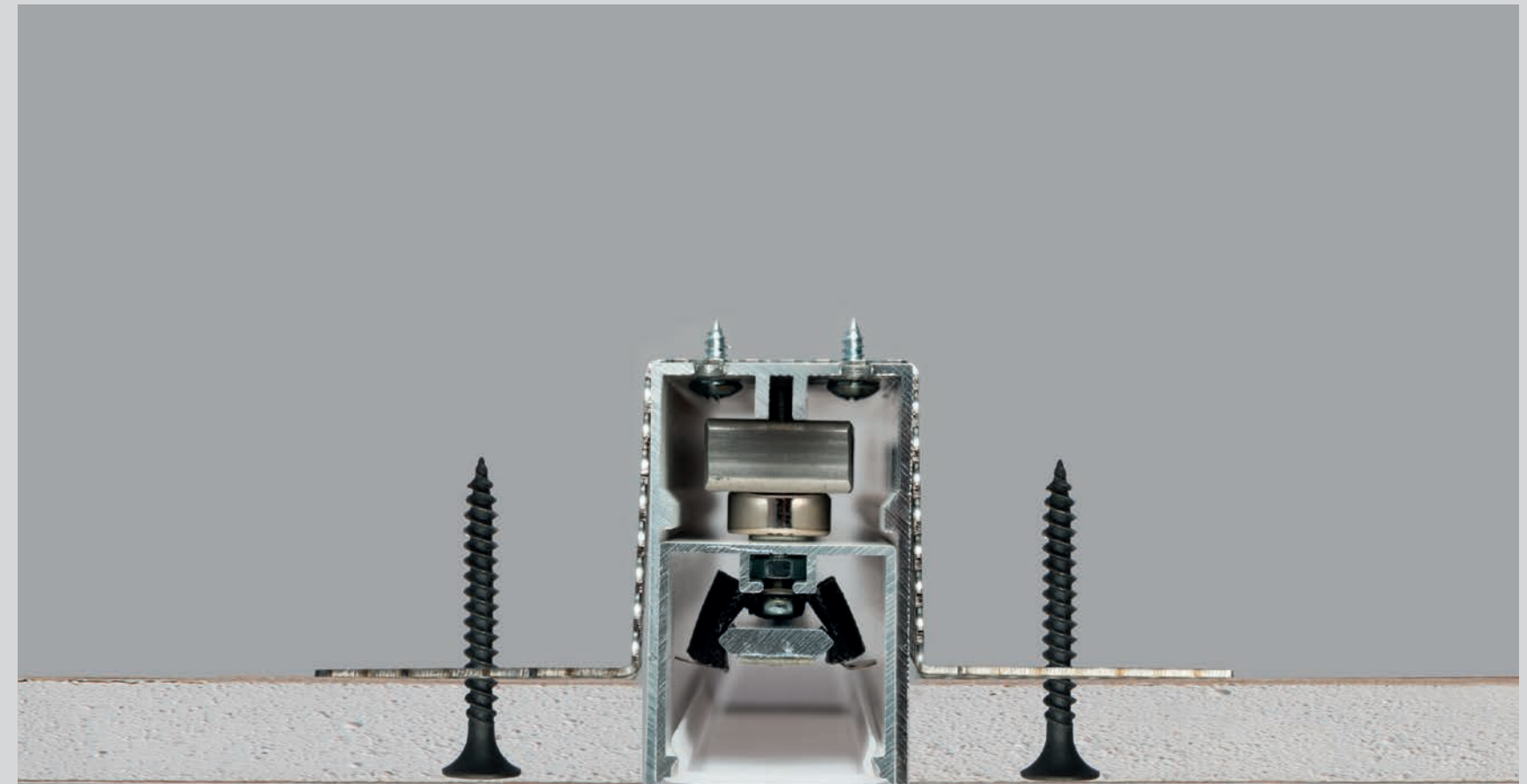
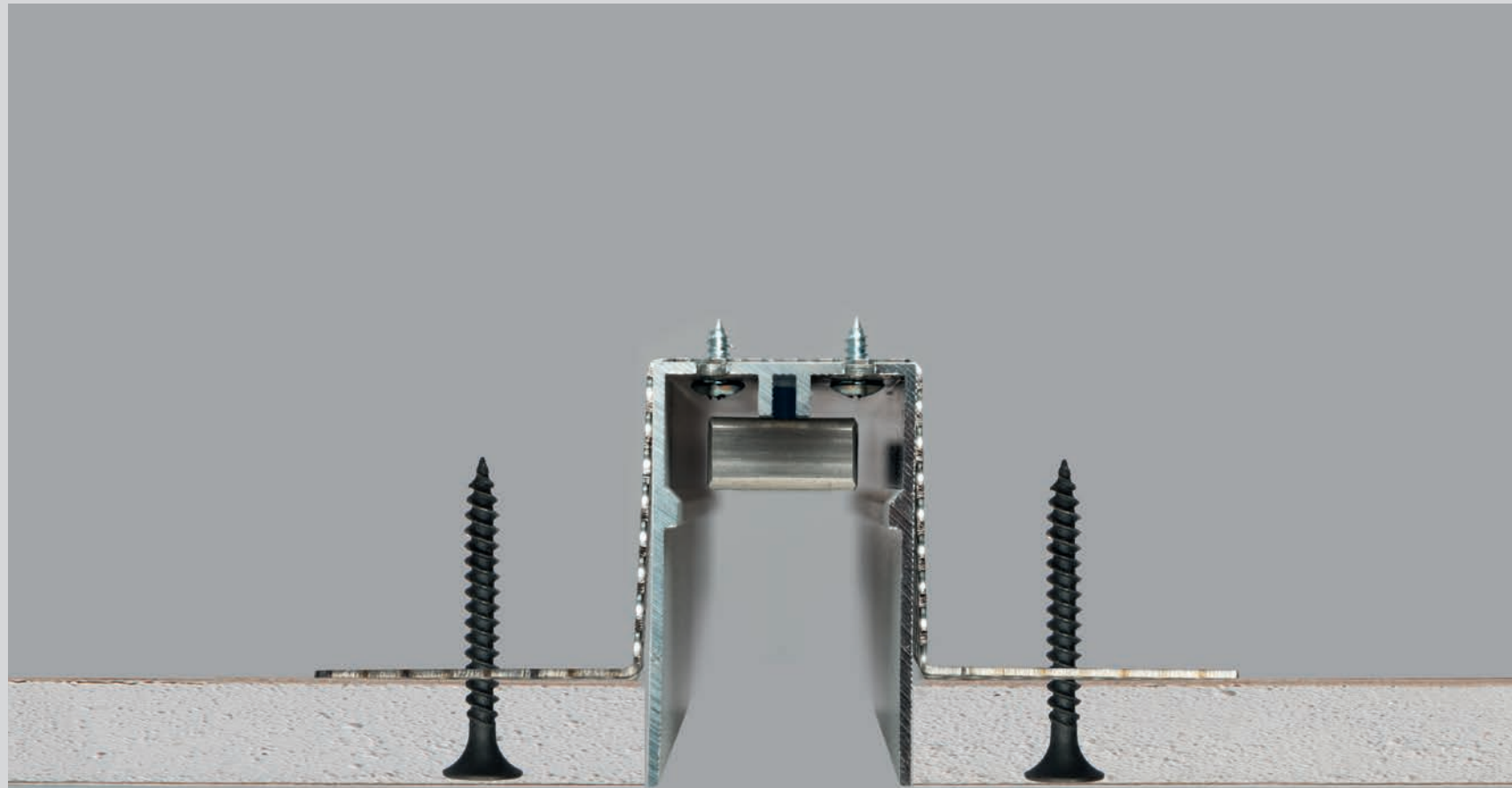

SISTEMA DI AGGANCIO RAPIDO TRAMITE MAGNETE
QUICK MAGNETIC ATTACHMENT SYSTEM

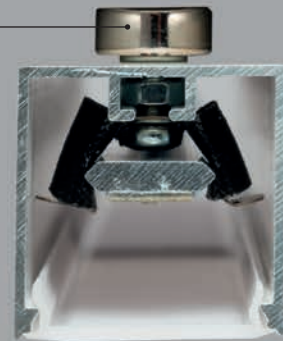

CODICE DESCRIZIONE / DESCRIPTION

ACCESSORI / ACCESSORIES

A6-031	Terminali di chiusura (coppia) / <i>End caps (pair)</i>
A6-032	Giunto lineare / <i>In-line connector</i>
A6-033	Terminali di chiusura per cassaforma (coppia) / <i>End caps for flush box (pair)</i>
X	Prolungamento + 32 mm per curva 90° / <i>Extension + 32 mm for a 90° corner</i>
Y	Prolungamento + 32 mm per curva 90° / <i>Extension + 32 mm for a 90° corner</i>
Z	Prolungamento + 32 mm per curva 90° / <i>Extension + 32 mm for a 90° corner</i>
K	Prolungamento + 32 mm per curva 90° / <i>Extension + 32 mm for a 90° corner</i>
W	Prolungamento + 32 mm per curva 90° / <i>Extension + 32 mm for a 90° corner</i>
0800/DIM	Dispositivo di dimmerazione (DIMMER) / <i>Dimming kit</i>
0800/EM	Kit di emergenza con pacco batterie / <i>Emergency kit with batteries</i>



Cod. X

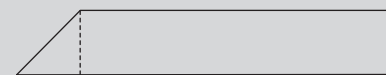

Cod. Y

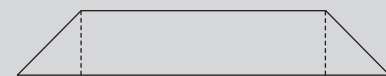

Cod. Z



Cod. K

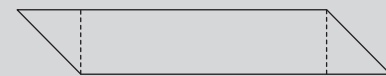

Cod. W

A richiesta altre tipologie di curva
Customized corner on request

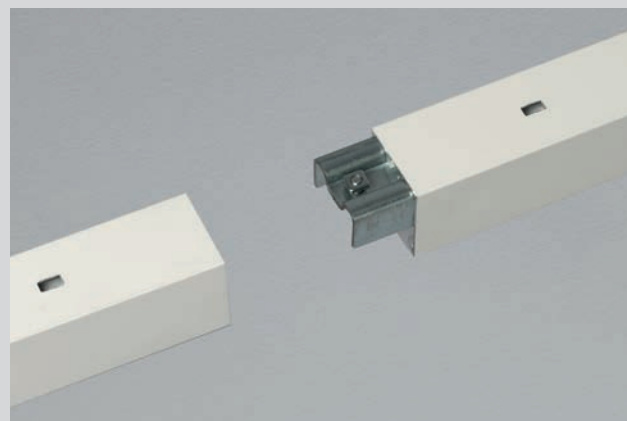

Giunto lineare / *In-line connector*

MINILINE

ACCESSORI / ACCESSORIES





AT

SISTEMA / SYSTEM

Profilo dalla forma sobria ma innovativa, studiato per generare un fascio di luce asimmetrico in grado di enfatizzare i volumi presenti nello spazio, AT è un sistema disponibile nelle versioni parete/plafone e incasso. Componibile su misura per multipli di 30 o 50 mm, è realizzato in alluminio verniciato a polvere epossipoliestere e fornito completo di fonte luminosa a LED. Necessita di driver remoto da 24Vdc (da ordinare separatamente) che, per la manutenzione, dovrà essere collocato in un vano ispezionabile posto ad una distanza non superiore a 10 metri. Il grado di protezione contro la penetrazione di polvere, corpi solidi e liquidi è IP20.

Basic yet innovative profile which creates an asymmetrical beam, AT is a modular fixture for wall/ceiling or recess. It is made from extruded epoxy polyester powder coated aluminium and it is equipped with LED light sources. This fixture requires a 24Vdc remote driver (to be ordered separately) which, for maintenance purposes, must be placed in an inspection box at a distance of no more than 10 metres. Its degree of protection against the penetration of dust, solid objects and liquids is IP20.

AT SISTEMA PARETE / PLAFONE / WALL / CEILING SYSTEM

CODICE	W	Lm (3000K)
A6-647.100...*	12 (120 led)	1200
A6-648.100...*	25 (280 led)	2500
A6-028	Terminali di chiusura (coppia) / <i>End caps (pair)</i>	
A6-029	Giunto lineare / <i>In-line connector</i>	
0800/DIM	Dispositivo di dimmerazione (DIMMER) / <i>Dimming kit</i>	
0800/EM	Kit di emergenza con pacco batterie / <i>Emergency kit with batteries</i>	

*codice al metro / *code per meter

driver 24Vdc remoto, escluso p. 301 / *remote driver not included p. 301*



Multipli di 50* mm, lunghezza max 4m Cod. A6-647
Multiples of 50 mm, max length 4m Cod. A6-647*

Multipli di 30* mm, lunghezza max 4m Cod. A6-648
Multiples of 30 mm, max length 4m Cod. A6-648*



***ATTENZIONE:** aggiungere 12,4 mm sulla lunghezza totale della composizione.

***NOTICE:** add 12,40 mm on the total length of the composition.

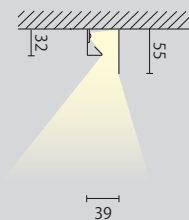

	100°
TC	3000K / 4000K
IP	20
CRI	>80
EEL	A+
RG	0
08	Bianco satinato



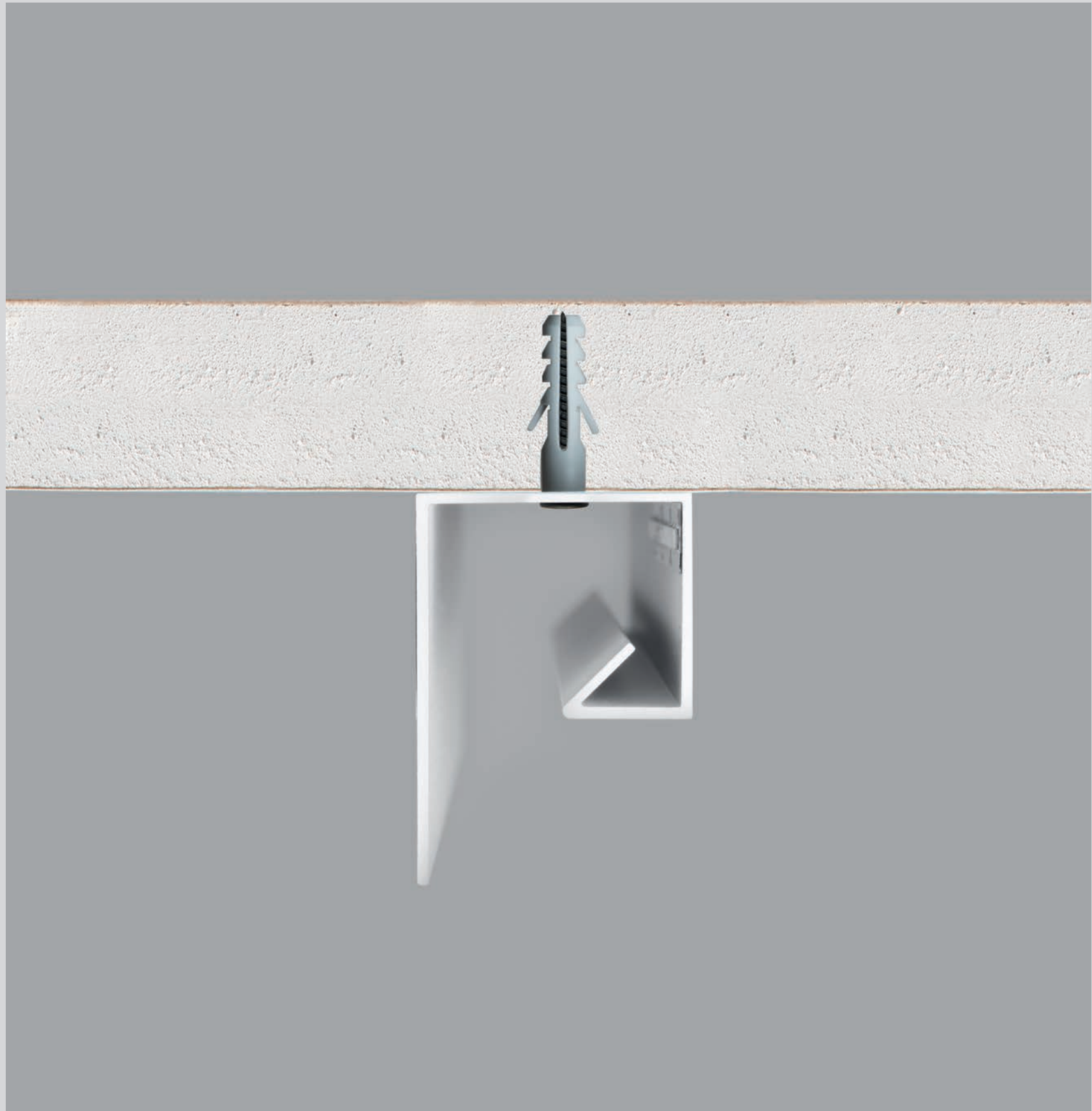
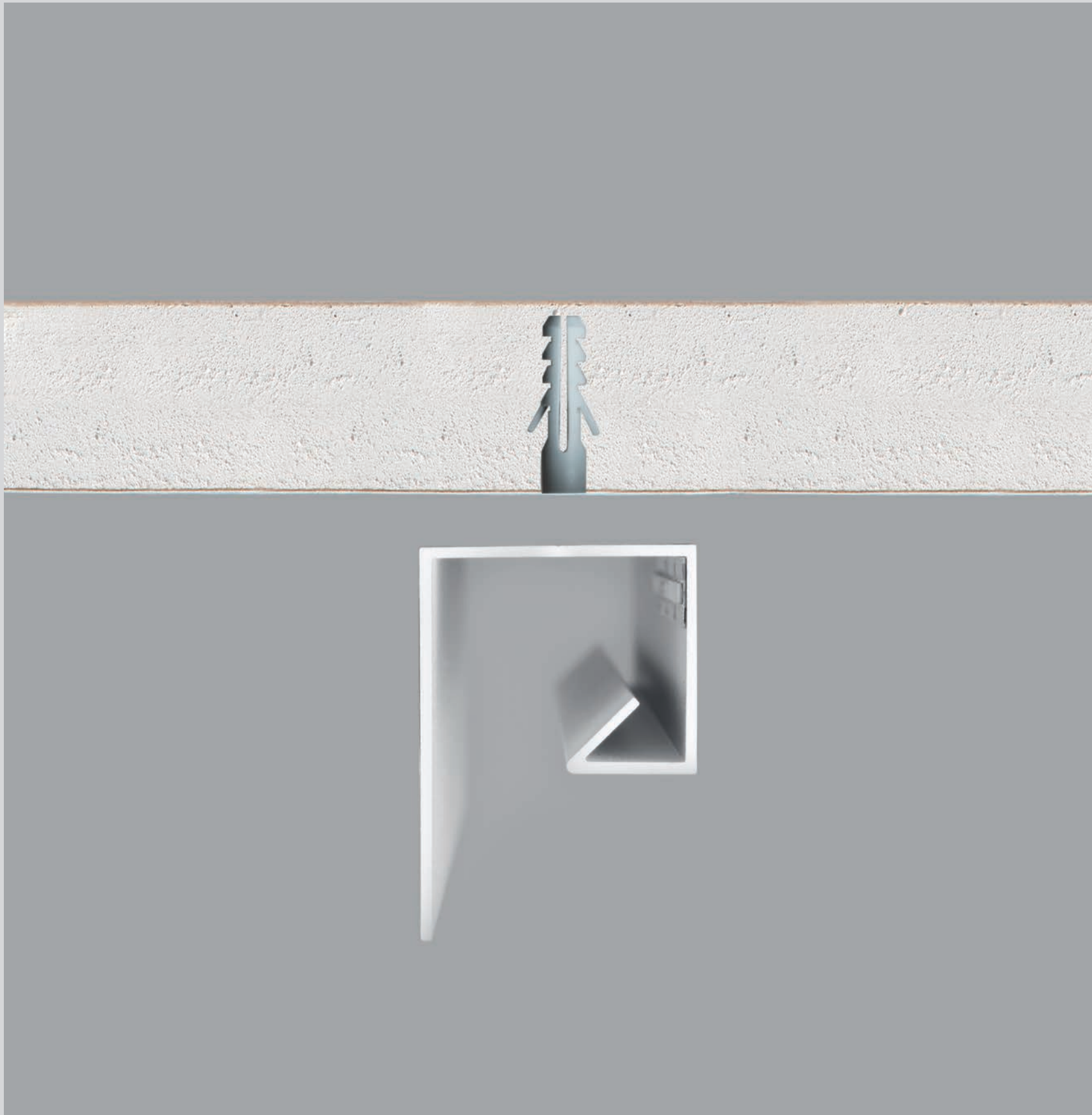

AT SISTEMA INCASSO / RECESSED SYSTEM

CODICE	W	Lm (3000K)
A6-645.100...*	12 (120 led)	1200
A6-646.100...*	25 (280 led)	2500
A6-030	Terminali di chiusura (coppia) / End caps (pair)	
A6-029	Giunto lineare / In-line connector	
0800/DIM	Dispositivo di dimmerazione (DIMMER) / Dimming kit	
0800/EM	Kit di emergenza con pacco batterie / Emergency kit with batteries	

*codice al metro / *code per meter
driver 24Vdc remoto, escluso p. 301 / remote driver not included p. 301



Multipli di 50 mm*, lunghezza max 4m Cod. A6-645
Multiples of 50 mm*, max length 4m Cod. A6-645

Multipli di 30 mm*, lunghezza max 4m Cod. A6-646
Multiples of 30 mm*, max length 4m Cod. A6-646

*ATTENZIONE: aggiungere a inizio e fine
composizione 2,5 mm

*NOTICE: add a 2.5 mm thickness to the beginning
and the end of the composition.

□ larghezza: 45 mm
□ lunghezza: aggiungere 12 mm alla lunghezza
totale della composizione.

□ width: 45 mm
□ length: add 12 mm to the total length of the
composition.



Abitazione privata, Arch. Loda

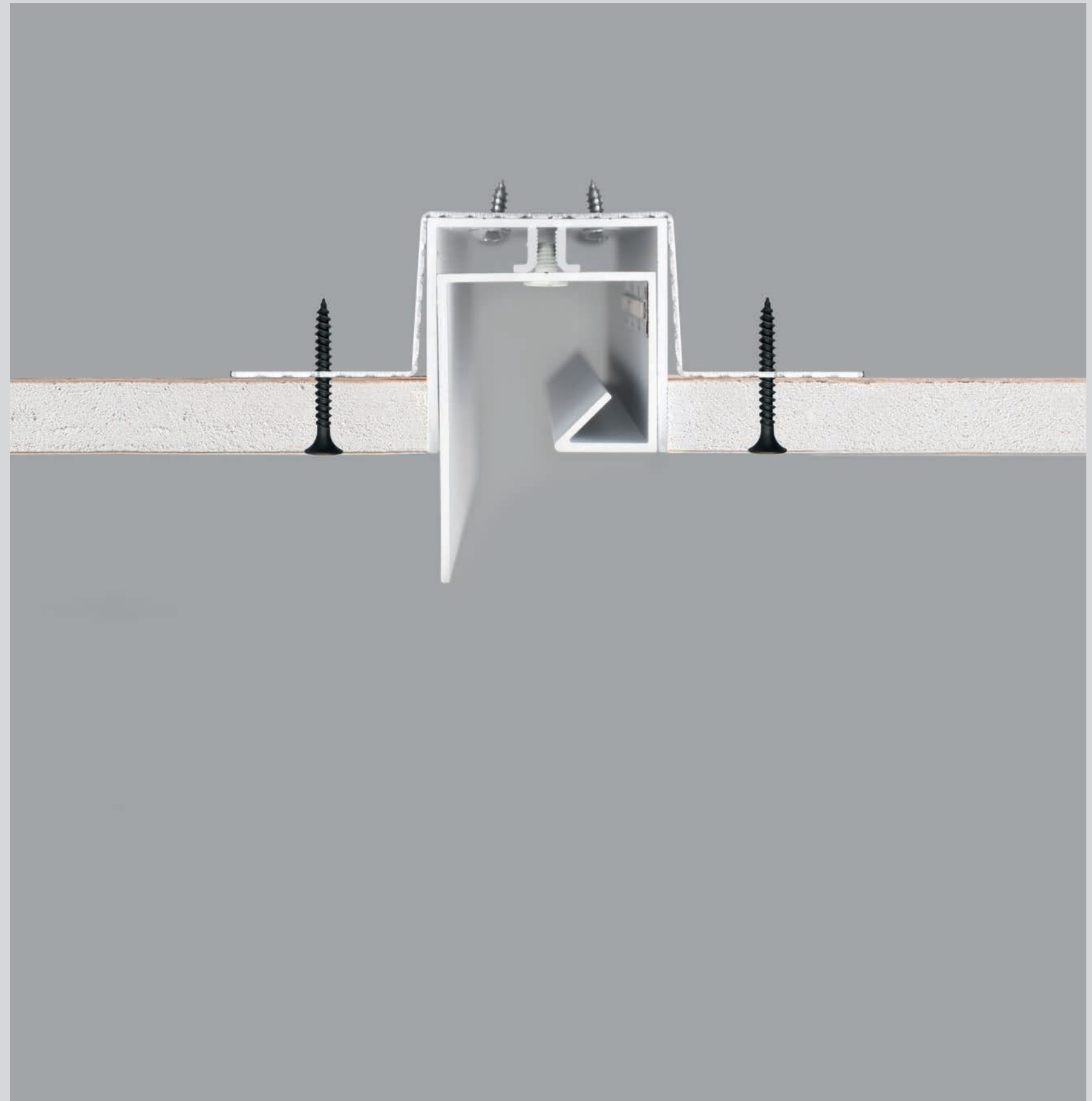
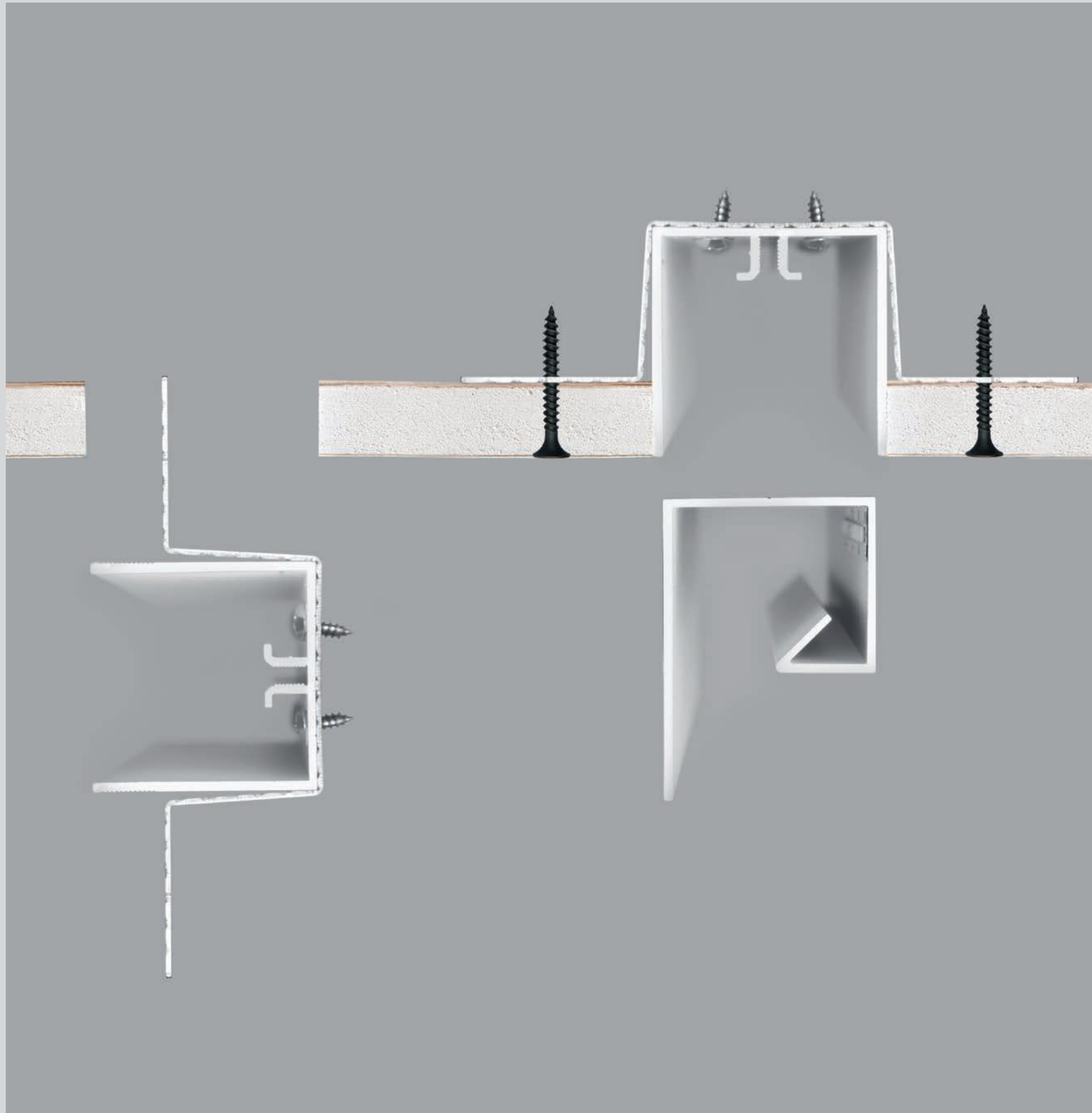



ESPO'







SISTEMA PARETE / WALL SYSTEM

CODICE	W	Lm (3000K)
A7-608.100...*	12 (120 led)	1200
A7-609.100...*	25 (280 led)	2500
A7-002	Terminali di chiusura (coppia) / End caps (pair)	
A7-000	Giunto lineare / In-line connector	
0800/DIM	Dispositivo di dimmerazione (DIMMER) Dimming kit	
0800/EM	Kit di emergenza con pacco batterie Emergency kit with batteries	

*codice al metro / *code per meter
driver 24Vdc remoto, escluso p. 301 / remote driver not included p. 301

Fonte di luce e contemporaneamente elemento espositivo, Espo' è un apparecchio da parete mono-emissione, componibile su misura per multipli di 30 o 50 mm. Realizzato in alluminio estruso verniciato a polvere epossipoliestere con schermo in policarbonato satinato, è fornito completo di fonte luminosa a LED. Necessita di driver da 24Vdc (da ordinare separatamente) che, per la manutenzione, dovrà essere collocato in un vano ispezionabile posto ad una distanza non superiore a 10 metri. Il grado di protezione contro la penetrazione di polvere, corpi solidi e liquidi è IP40.

Not only a source of light but also an elegant display shelf. Espo' is a modular single emission wall luminaire. It is made from extruded epoxy polyester powder coated aluminium and it is equipped with a frosted polycarbonate screen and LED light sources. This fixture requires a 24Vdc remote driver (to be ordered separately) which, for maintenance purposes, must be placed in an inspection box at a distance of no more than 10 metres. Its degree of protection against the penetration of dust, solid objects and liquids is IP40.

-  75°
-  TC 3000K / 4000K
-  IP 40
-  CRI >80
-  EEI A+
-  RG 0
-  08 Bianco satinato (altri colori a richiesta) (other colours on request)

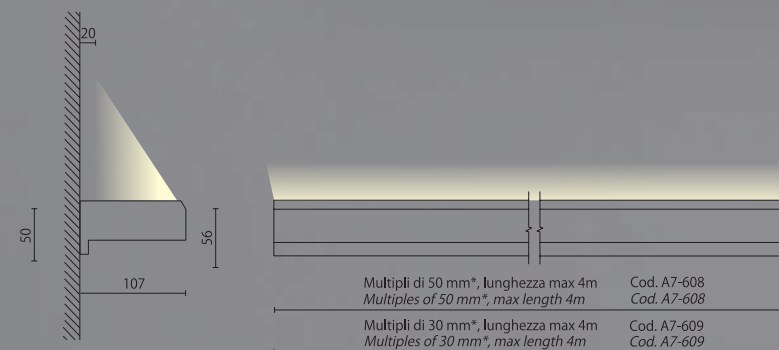

*ATTENZIONE: aggiungere 10 mm sulla lunghezza totale della composizione.
*NOTICE: add 10 mm on the total length of the composition.

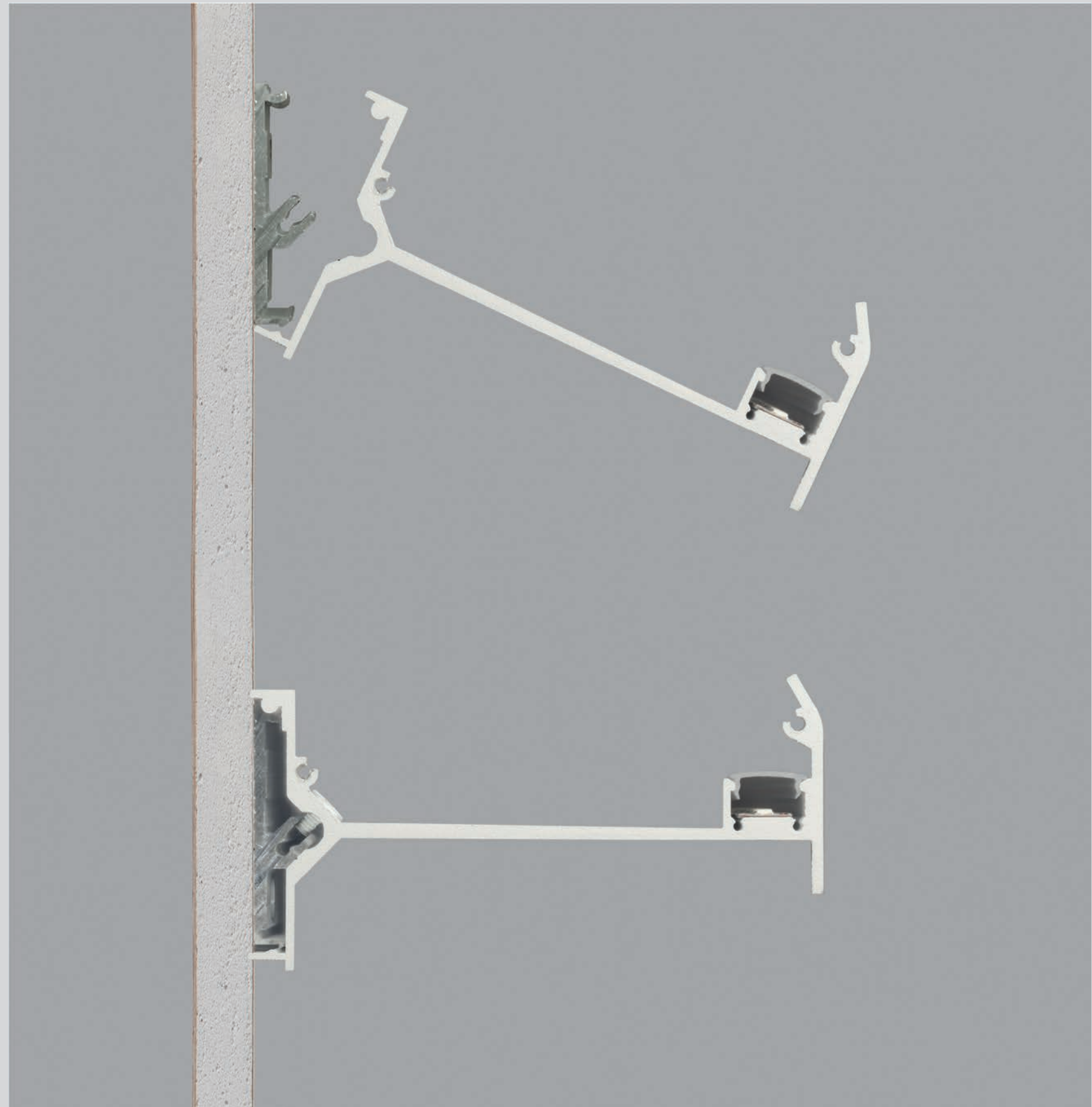
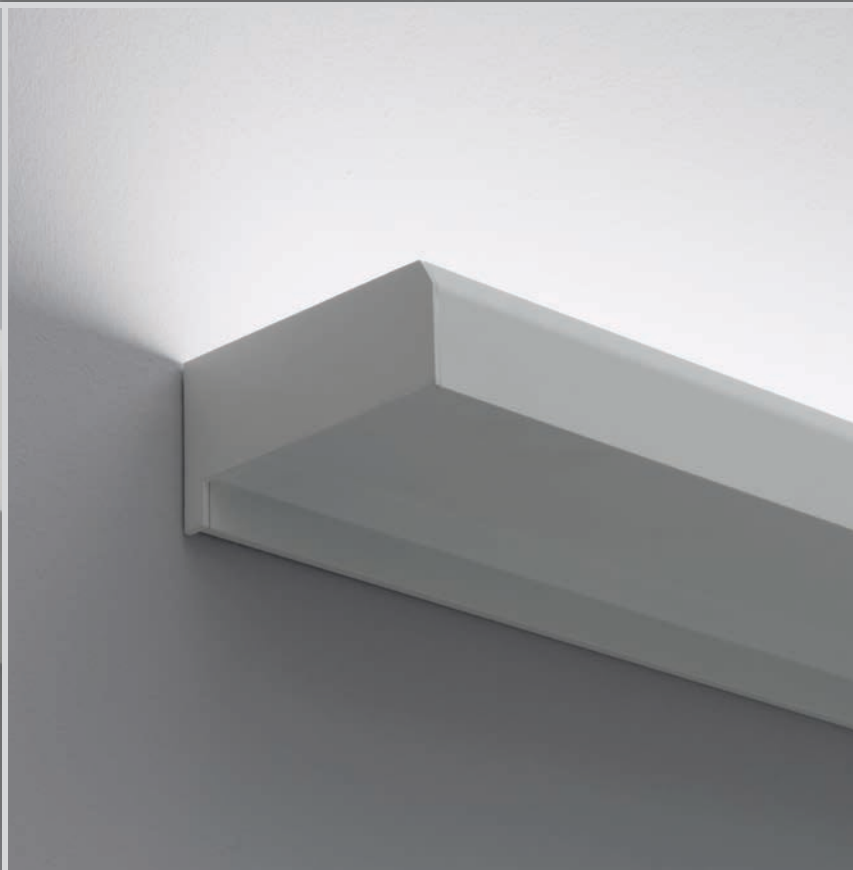
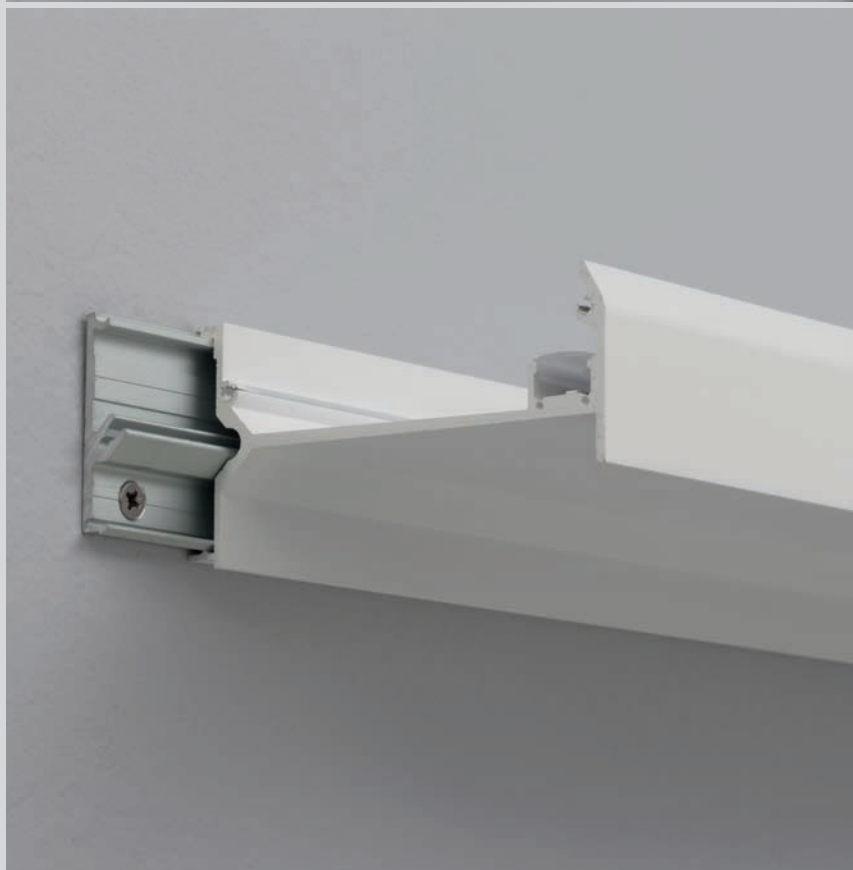





Abitazione privata, Brescia

ESPO' 2

SISTEMA PARETE / PLAFONE / WALL / CEILING SYSTEM

CODICE	W	Lm (3000K)
A7-608.2.100...*	2x12 (2x120 led)	2x1200
A7-609.2.100...*	2x25 (2x280 led)	2x2500
A7-002.2	Terminali di chiusura (coppia) / <i>End caps (pair)</i>	
A7-000.2	Giunto lineare / <i>In-line connector</i>	
0800/DIM	Dispositivo di dimmerazione (DIMMER) <i>Dimming kit</i>	
0800/EM	Kit di emergenza con pacco batterie <i>Emergency kit with batteries</i>	

*codice al metro / *code per meter
driver 24Vdc remoto, escluso p. 301 / *remote driver not included p. 301*

Pensato sia per integrarsi nell'ambiente delimitandone gli spazi in maniera armoniosa sia per creare particolari soluzioni espositive, Esposito' 2 è un apparecchio da parete/plafone a doppia emissione, componibile su misura per multipli di 30 o 50 mm. Realizzato in alluminio estruso verniciato a polvere epossipoliestere con schermo in policarbonato satinato, è fornito completo di fonte luminosa a LED. Necessita di driver remoto da 24Vdc (da ordinare separatamente) che, per la manutenzione, dovrà essere collocato in un vano ispezionabile posto ad una distanza non superiore a 10 metri. Il grado di protezione contro la penetrazione di polvere, corpi solidi e liquidi è IP40.

A wall/ceiling fixture designed to be integrated with the environment, delimiting spaces harmoniously and creating unique display solutions. Esposito' 2 is a modular double emission wall luminaire made from extruded epoxy polyester powder coated aluminium and it is equipped with a frosted polycarbonate screen and LED light sources. This fixture requires a 24Vdc remote driver (to be ordered separately) which, for maintenance purposes, must be placed in an inspection box at a distance of no more than 10 metres. Its degree of protection against the penetration of dust, solid objects and liquids is IP40.

	75°
TC	3000K / 4000K
IP	40
CRI	>80
EEL	A+
RG	0
08	Bianco satinato (altri colori a richiesta) (other colours on request)

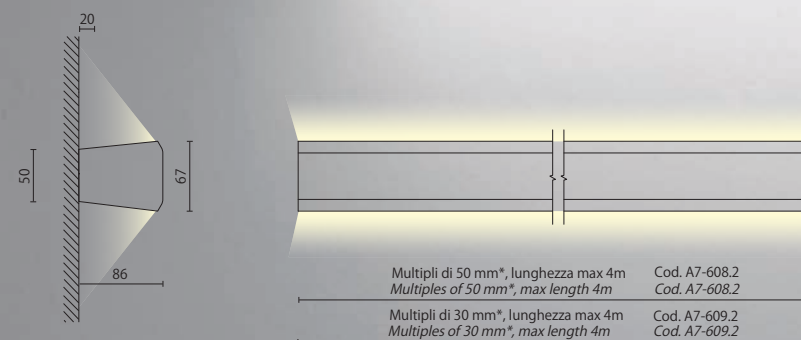

*ATTENZIONE: aggiungere 10 mm sulla lunghezza totale della composizione.
*NOTICE: add 10 mm on the total length of the composition.



Abitazione privata, Brescia

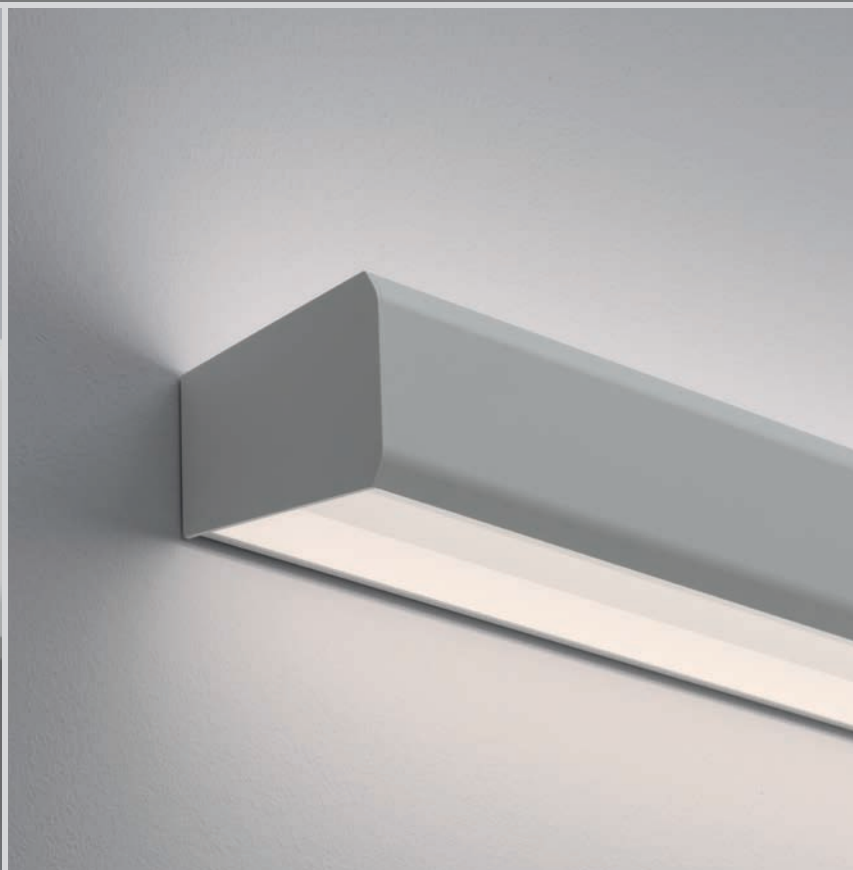

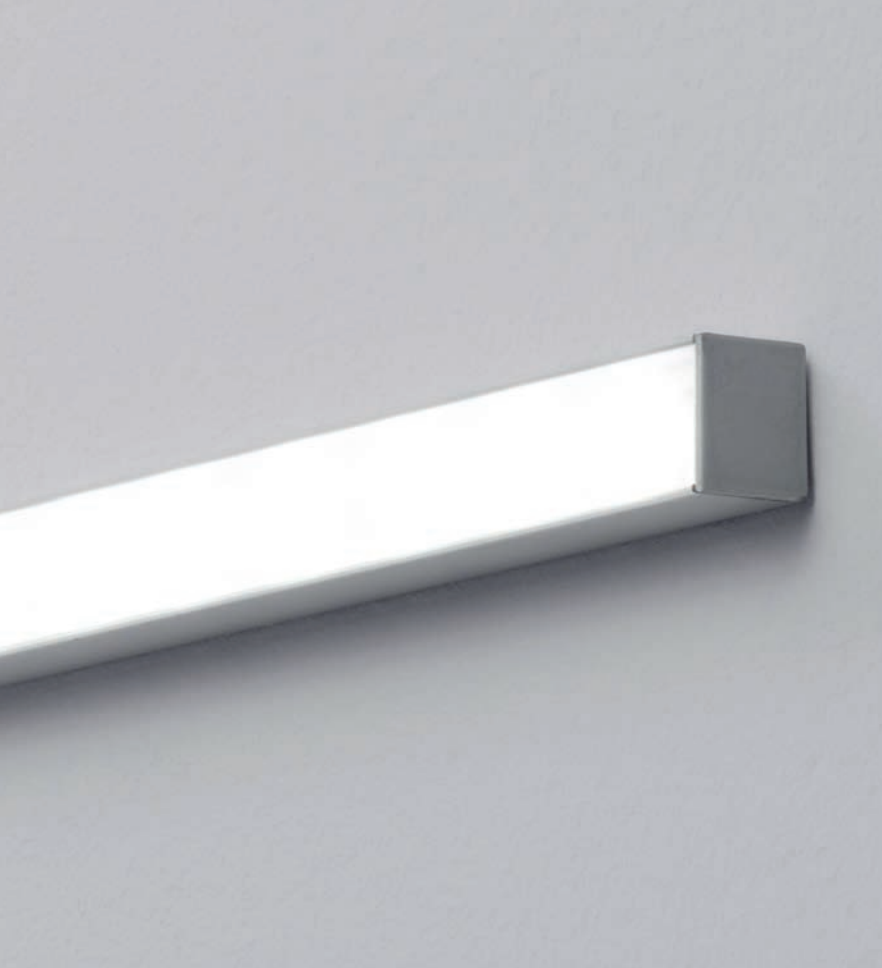

FROY

CODICE	W	Lm (3000K)
A7-603.F100...*	12 (120 led)	1200
A7-604.F100...*	25 (280 led)	2500
A7-004F	Terminali di chiusura (coppia) / <i>End caps (pair)</i>	
0800/DIM	Dispositivo di dimmerazione (DIMMER) / <i>Dimming kit</i>	
0800/EM	Kit di emergenza con pacco batterie / <i>Emergency kit with batteries</i>	

*codice al metro / *code per meter

driver 24Vdc remoto, escluso p. 301 / *remote driver not included p. 301*



ASY

CODICE	W	Lm (3000K)
A7-603.A100...*	12 (120 led)	1200
A7-604.A100...*	25 (280 led)	2500
A7-004A	Terminali di chiusura (coppia) / <i>End caps (pair)</i>	
0800/DIM	Dispositivo di dimmerazione (DIMMER) / <i>Dimming kit</i>	
0800/EM	Kit di emergenza con pacco batterie / <i>Emergency kit with batteries</i>	

*codice al metro / *code per meter

driver 24Vdc remoto, escluso p. 301 / *remote driver not included p. 301*

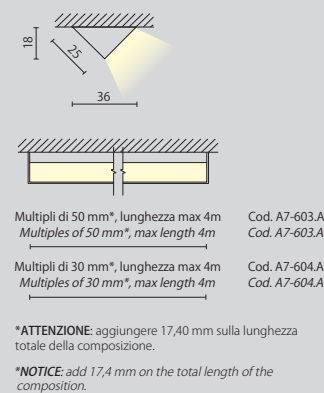

FROY

SISTEMA PARETE / PLAFONE / WALL / CEILING SYSTEM

Profilo dalle ridottissime dimensioni e dal minimo impatto visivo, Froy è un apparecchio monoemissione da parete/plafone su misura. Realizzato in alluminio verniciato a polvere epossipoliestere, è fornito completo di fonte luminosa a LED e di schermo in policarbonato satinato. Necessita di driver remoto da 24Vdc (da ordinare separatamente) che, per la manutenzione, dovrà essere collocato in un vano ispezionabile posto ad una distanza non superiore a 10 metri. Il grado di protezione contro la penetrazione di polvere, corpi solidi e liquidi è IP40.

Tiny dimensions and minimal visual effects characterize Froy, a modular single emission luminaire for wall or ceiling. It is made from extruded epoxy polyester powder coated aluminium and it is equipped with a frosted polycarbonate screen and LED light sources. This fixture requires a 24Vdc remote driver (to be ordered separately) which, for maintenance purposes, must be placed in an inspection box at a distance of no more than 10 metres. Its degree of protection against the penetration of dust, solid objects and liquids is IP40.

	105°
TC	3000K / 4000K
IP	40
CRI	>80
EEL	A+
RG	0
02	Nero opaco
09	Bianco opaco

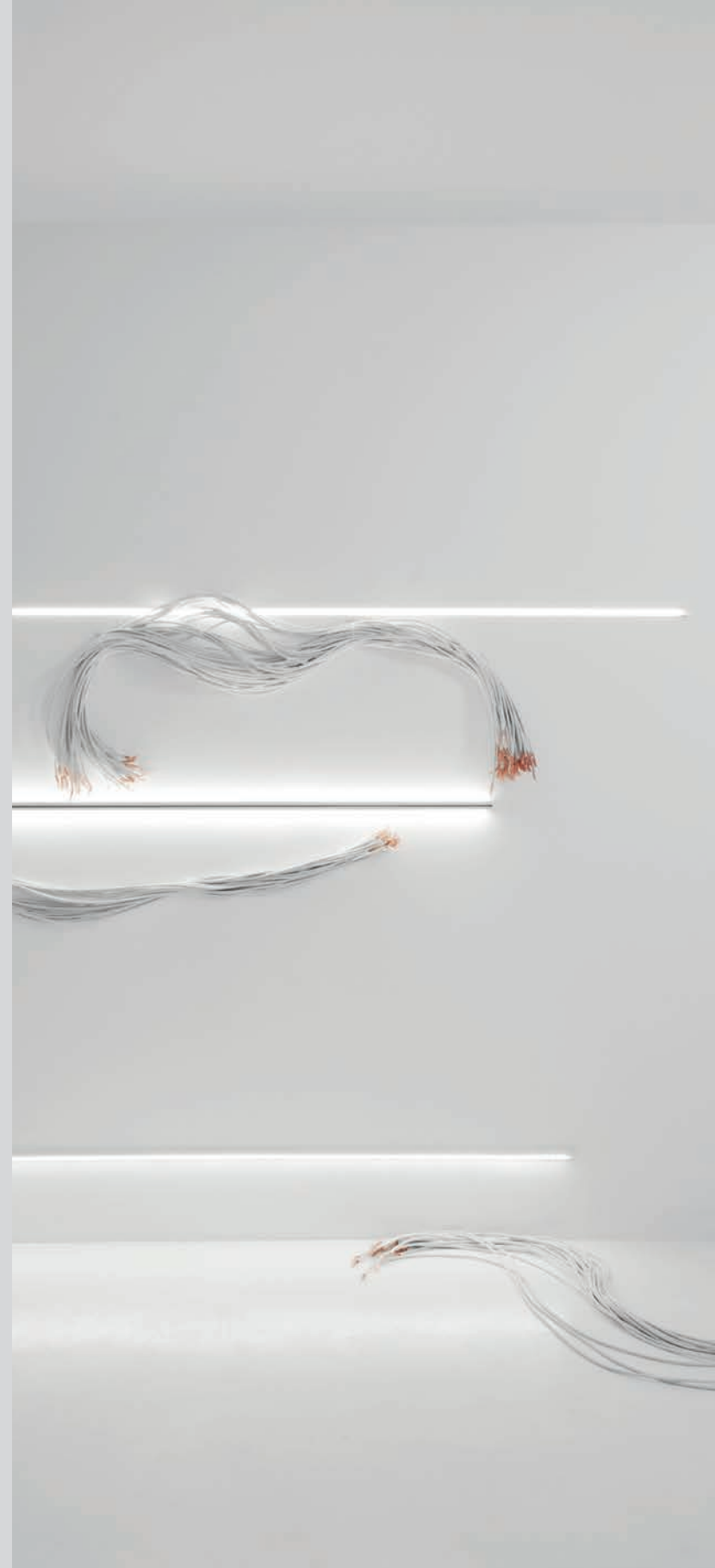

ASY

SISTEMA PARETE / PLAFONE / WALL / CEILING SYSTEM

Ideale per proiettare una luce morbida ed asimmetrica, Asy è un apparecchio monoemissione da parete/plafone su misura. Realizzato in alluminio verniciato a polvere epossipoliestere, è fornito completo di fonte luminosa a LED e di schermo in policarbonato satinato. Necessita di driver remoto da 24Vdc (da ordinare separatamente) che, per la manutenzione, dovrà essere collocato in un vano ispezionabile posto ad una distanza non superiore a 10 metri. Il grado di protezione contro la penetrazione di polvere, corpi solidi e liquidi è IP40.

Designed to cast a soft and asymmetrical beam, Asy is a modular single emission luminaire for wall or ceiling. It is made from extruded epoxy polyester powder coated aluminium and it is equipped with a frosted polycarbonate screen and LED light sources. This fixture requires a 24Vdc remote driver (to be ordered separately) which, for maintenance purposes, must be placed in an inspection box at a distance of no more than 10 metres. Its degree of protection against the penetration of dust, solid objects and liquids is IP40.

	-
TC	3000K / 4000K
IP	40
CRI	>80
EEL	A+
RG	0
02	Nero opaco
09	Bianco opaco

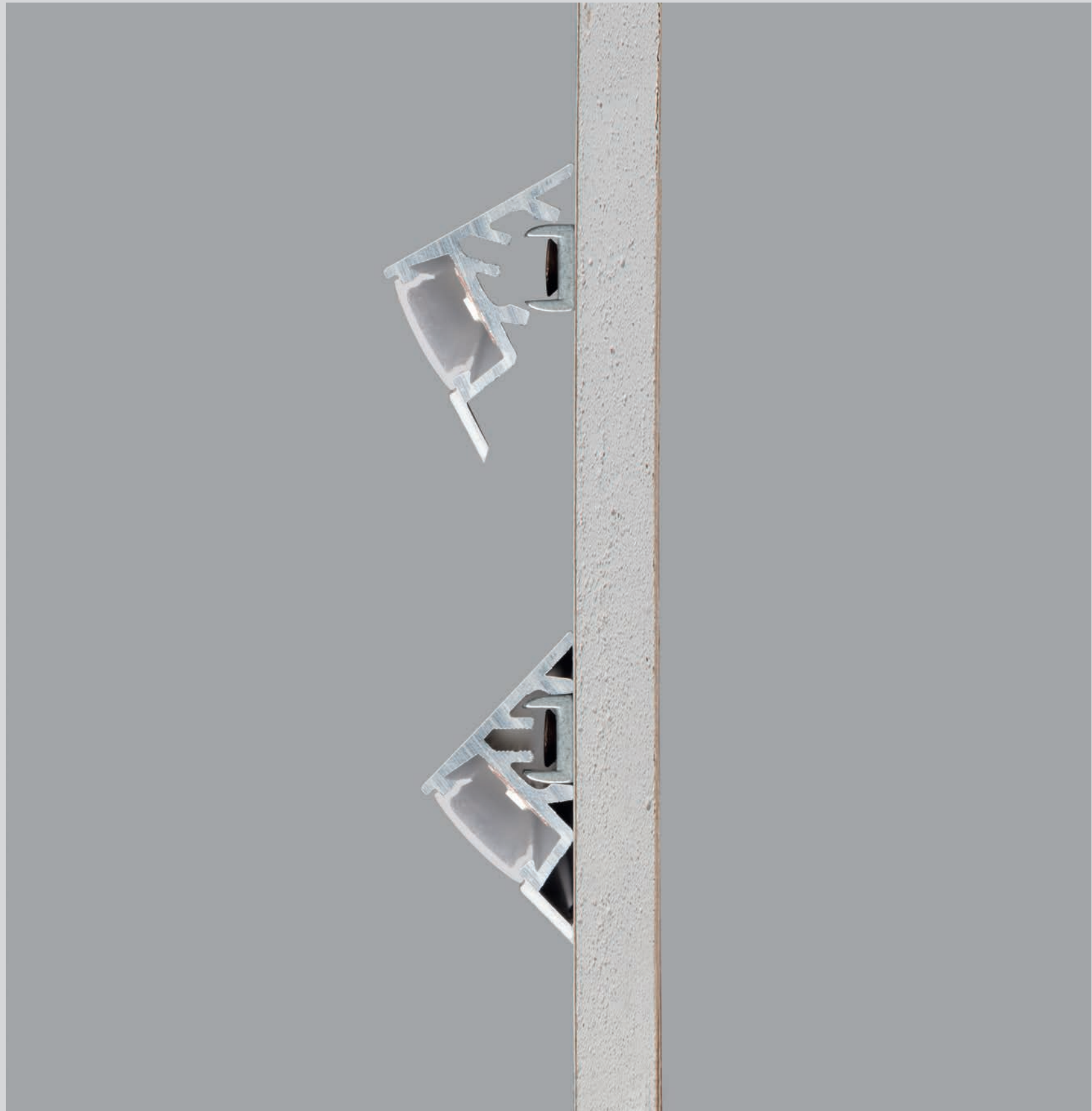
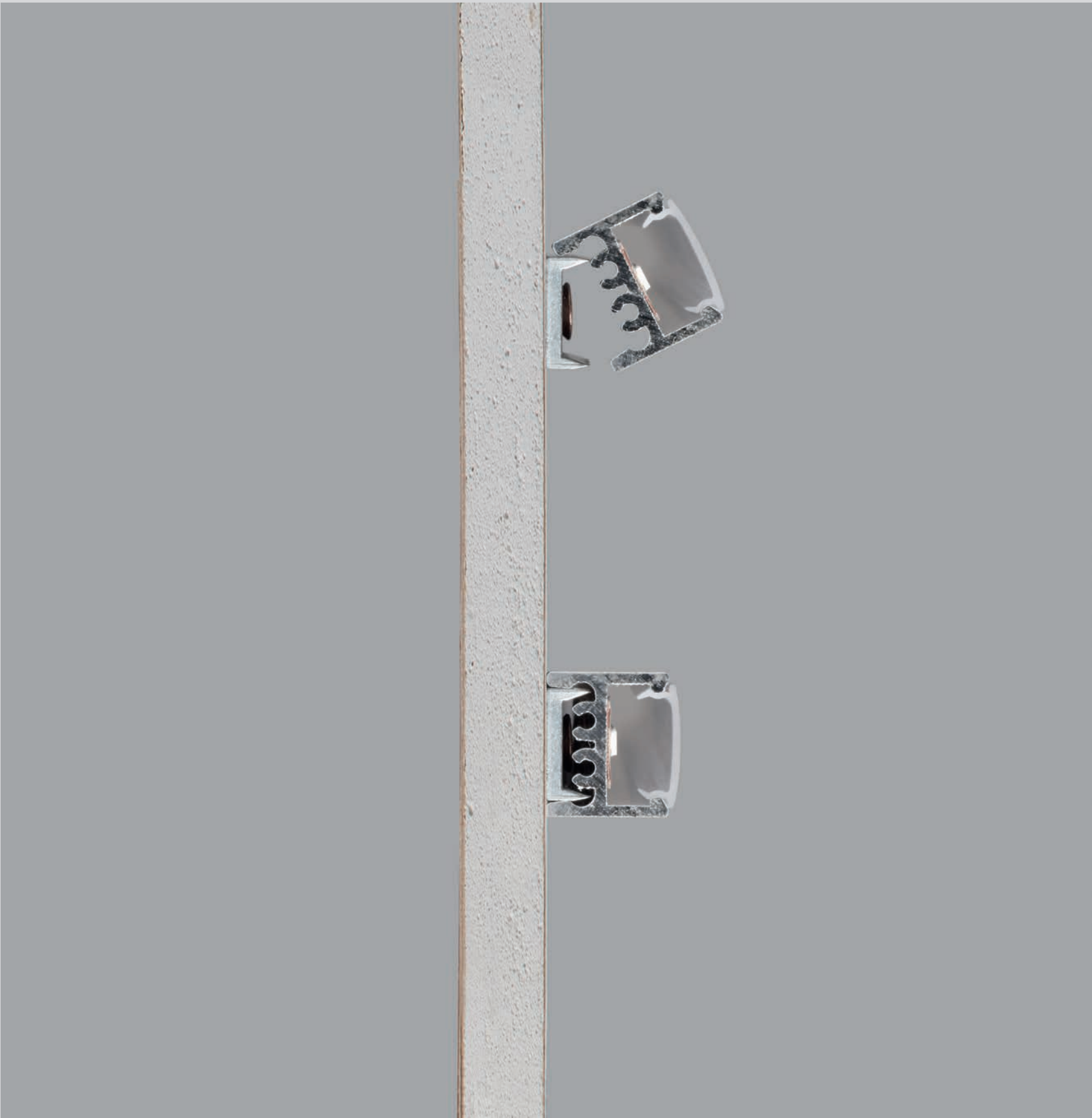



Abitazione privata, Varese

	105°
TC	3000K / 4000K
IP	40
CRI	>80
EEL	A+
RG	0
02	Nero opaco
09	Bianco opaco

LATY

SISTEMA PARETE / PLAFONE / WALL / CEILING SYSTEM

Profilo caratterizzato dal contrasto tra la luce emessa sui due lati e il taglio d'ombra che lo percorre frontalmente per tutta la sua lunghezza, Laty è un apparecchio biemissione da parete/plafone su misura. Realizzato in alluminio verniciato a polvere epossipoliestere, è fornito completo di fonte luminosa a LED e di schermo in policarbonato satinato. Necessita di driver remoto da 24Vdc (da ordinare separatamente) che, per la manutenzione, dovrà essere collocato in un vano ispezionabile posto ad una distanza non superiore a 10 metri. Il grado di protezione contro la penetrazione di polvere, corpi solidi e liquidi è IP40.

Characterized by a dark cut on its surface, which contrasts with the light cast from the sides of the luminaire, Laty is a modular double emission luminaire for wall or ceiling. It is made from epoxy polyester powder coated aluminium and it is equipped with a frosted polycarbonate screen and LED light sources. This fixture requires a 24Vdc remote driver (to be ordered separately) which, for maintenance purposes, must be placed in an inspection box at a distance of no more than 10 metres. Its degree of protection against the penetration of dust, solid objects and liquids is IP40.

LATY

CODICE	W	Lm (3000K)
A7-603.L100...*	2x12 (2x120 led)	2x1200
A7-604.L100...*	2x25 (2x280 led)	2x2500
A7-004L	Terminali di chiusura (coppia) / <i>End caps (pair)</i>	
0800/DIM	Dispositivo di dimmerazione (DIMMER) / <i>Dimming kit</i>	
0800/EM	Kit di emergenza con pacco batterie / <i>Emergency kit with batteries</i>	

*codice al metro / *code per meter

driver 24Vdc remoto, escluso p. 301 / *remote driver not included p. 301*

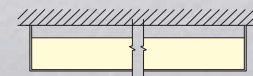
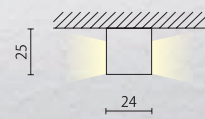

Multipli di 50 mm*, lunghezza max 4m
Multiples of 50 mm, max length 4m*

Cod. A7-603.L
 Cod. A7-603.L

Multipli di 30 mm*, lunghezza max 4m
Multiples of 30 mm, max length 4m*

Cod. A7-604.L
 Cod. A7-604.L

***ATTENZIONE:** aggiungere 17,40 mm sulla lunghezza totale della composizione.

***NOTICE:** add 17,4 mm on the total length of the composition.

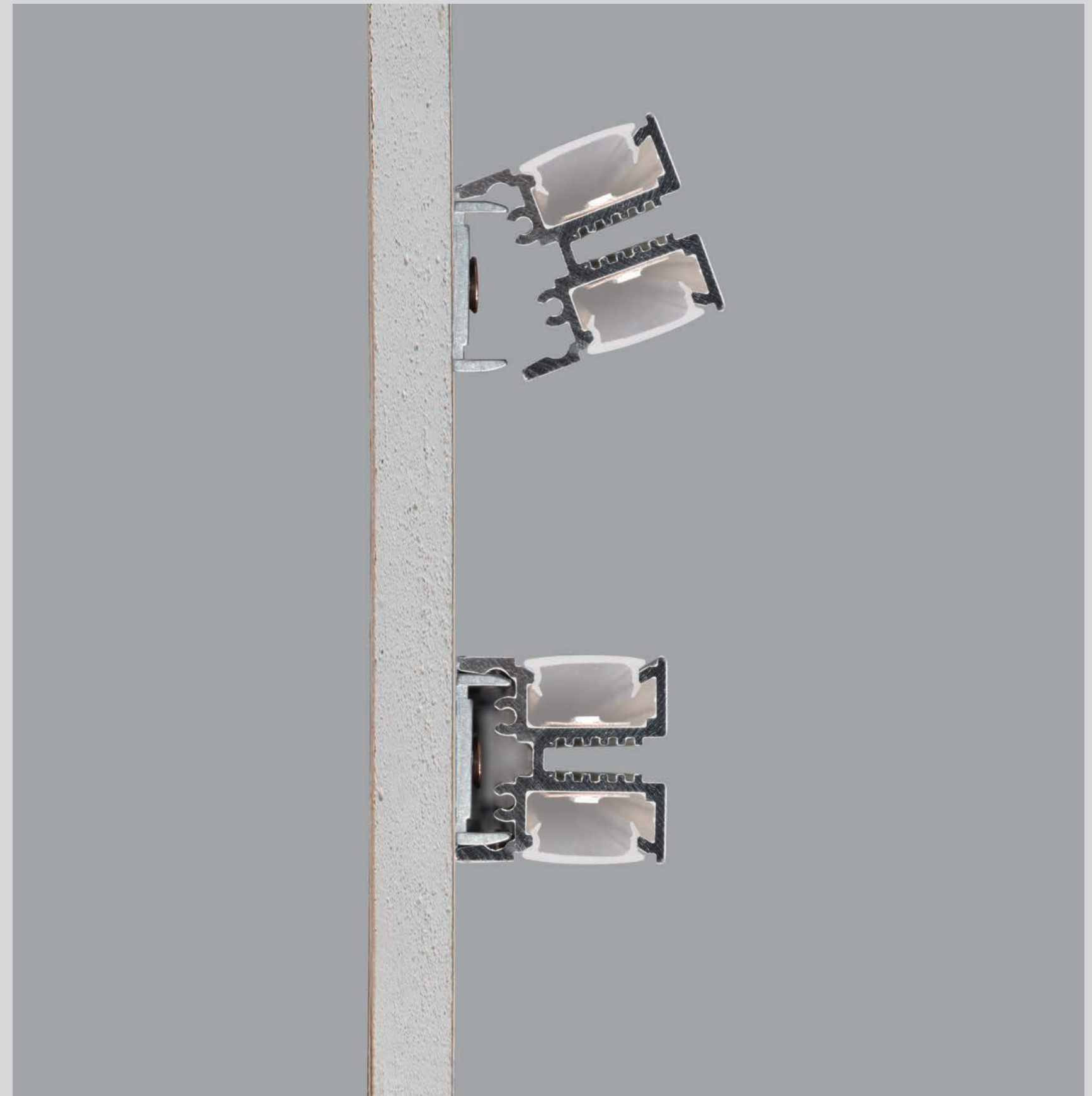



FROY PROFILO VUOTO / EMPTY BODY SECTION

Profilo in alluminio verniciato completo di schermo in policarbonato satinato. Driver da 24Vdc escluso.
Empty body section made from epoxy polyester powder coated aluminium. Complete with frosted polycarbonate screen. 24Vdc driver not included.

CODICE	DESCRIZIONE / DESCRIPTION
ESAL200F	Froy 2 metri / Froy 200 cm
ESAL100F	Froy taglio a misura*, Max 4mt / Froy customized length*, Max 4mt
A7-004F	tappi (coppia), in alluminio sinterizzato / End caps (pair), in sintered aluminium
A7-005F	elemento di fissaggio (singolo), in alluminio sinterizzato fixing support (single), in sintered aluminium

*il codice si riferisce al profilo di lunghezza 100 cm / *the code refers to a module with a length measuring 100 cm

Per richieste di profili con lunghezze differenti, sostituire il codice 100 con la lunghezza in centimetri desiderata.
To order modules in different lengths substitute code 100 with the desired length in centimeters.



ASY PROFILO VUOTO / EMPTY BODY SECTION

Profilo in alluminio verniciato completo di schermo in policarbonato satinato. Driver da 24Vdc escluso.
Empty body section made from epoxy polyester powder coated aluminium. Complete with frosted polycarbonate screen. 24Vdc driver not included.

CODICE	DESCRIZIONE / DESCRIPTION
ESAL200A	Asy 2 metri / Froy 200 cm
ESAL100A	Asy taglio a misura*, Max 4mt / Froy customized length*, Max 4mt
A7-004A	tappi (coppia), in alluminio sinterizzato / End caps (pair), in sintered aluminium
A7-005A	elemento di fissaggio (singolo), in alluminio sinterizzato fixing support (single), in sintered aluminium

*il codice si riferisce al profilo di lunghezza 100 cm / *the code refers to a module with a length measuring 100 cm

Per richieste di profili con lunghezze differenti, sostituire il codice 100 con la lunghezza in centimetri desiderata.
To order modules in different lengths substitute code 100 with the desired length in centimeters.



LATY PROFILO VUOTO / EMPTY BODY SECTION

Profilo in alluminio verniciato completo di schermo in policarbonato satinato. Driver da 24Vdc escluso.
Empty body section made from epoxy polyester powder coated aluminium. Complete with frosted polycarbonate screen. 24Vdc driver not included.

CODICE	DESCRIZIONE / DESCRIPTION
ESAL200L	Laty 2 metri / Froy 200 cm
ESAL100L	Laty taglio a misura*, Max 4mt / Froy customized length*, Max 4mt
A7-004L	tappi (coppia), in alluminio sinterizzato / End caps (pair), in sintered aluminium
A7-005L	elemento di fissaggio (singolo), in alluminio sinterizzato fixing support (single), in sintered aluminium

*il codice si riferisce al profilo di lunghezza 100 cm / *the code refers to a module with a length measuring 100 cm

Per richieste di profili con lunghezze differenti, sostituire il codice 100 con la lunghezza in centimetri desiderata.
To order modules in different lengths substitute code 100 with the desired length in centimeters.

ACCESSORI ESCLUSI / ACCESSORIES NOT INCLUDED

LED 24Vdc LUNGHEZZA 5 METRI / LED 24Vdc, 5M LONG

CODICE	LED/mt	TC (K)	W/mt	Lm/mt
STR50012120.30	120	3000	12	1200
STR50012120.40	120	4000	12	1320
STR50025280.30	280	3000	25	2500
STR50025280.40	280	4000	25	2650

LED strip mt 5 con biadesivo termico 3M / 5 mt strip LED with double-sided thermal adhesive tape
 La versione da 120 LED/mt è divisibile in tagli da 5 cm / 120 LED/mt version divisible every 5 cm
 La versione da 280 LED/mt è divisibile in tagli da 2,5 cm / 240 LED/mt version divisible every 2,5 cm
 Alimentazione 24Vdc / 24Vdc power supply

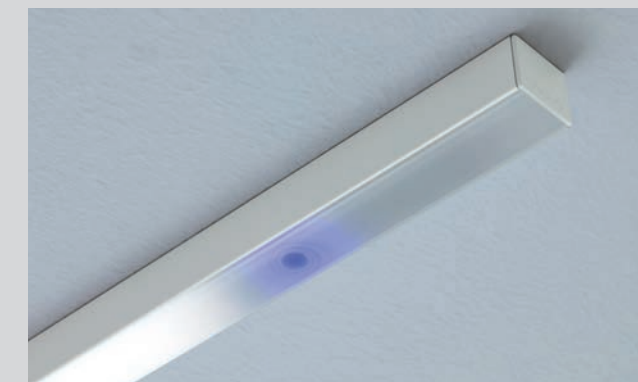

INTERRUTTORE ON/OFF TOUCH / TOUCH SWITCH ON/OFF

Interruttore touch con LED blu di segnalazione della zona di accensione/spegnimento.
 Spazio necessario per l'installazione minimo 80 mm. Fornito senza cavi.
 Necessita di connessione elettrica tramite saldatura.

*Touch switch with blue LED on/off indicator.
 Minimal space required for installation: 80 mm. Cables not included.
 Electrical connection by welding is required.*

CODICE	W	DIMENSIONI (LxWxH)
07-010	Max 36	60x11,5mm

DRIVER IN TENSIONE CONTINUA 24Vdc / DIRECT CURRENT DRIVER 24Vdc

CODICE	W	IP	DIMENSIONI (LxWxH)
0730	20	67	118x35x26mm
0731	35	67	148x40x30mm
0732	60	67	163x43x32mm
0733	100	67	190x52x37mm
0734	150	67	191x67x38mm
0735	185	67	229x68x39mm
0736	240	67	251x68x39mm
0731/DIMM 2-3	35	20	195x43x30mm
0732/DIMM 2-3	60	20	225x43x30mm
0733/DIMM 2-3	100	20	295x43x30mm
0734/DIMM 2-3	150	20	325x43x30mm

- 02 Nero opaco
- 09 Bianco opaco

ESTERNI
OUTDOOR

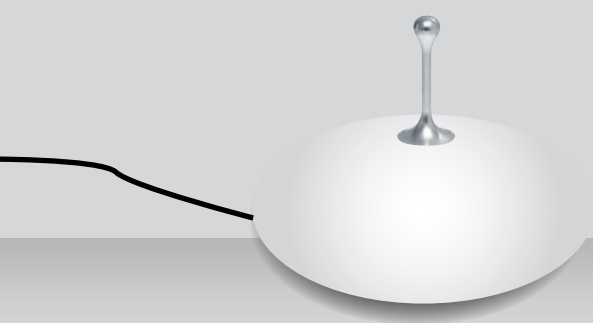
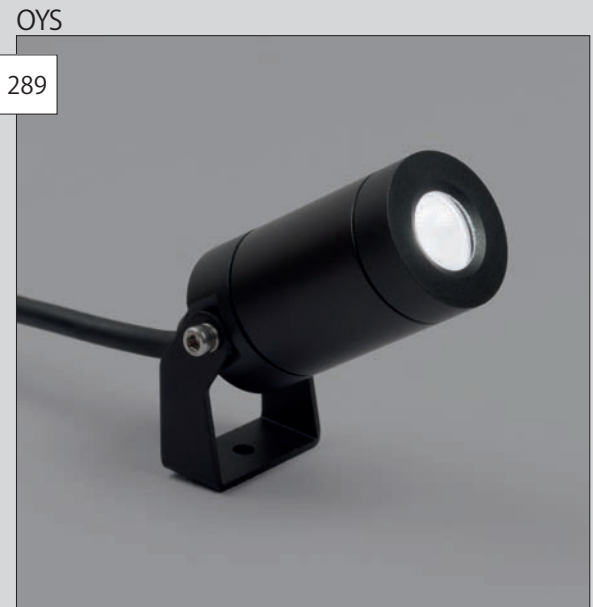



CABANA

ESTERNO / OUTDOOR

Forma briosa e raffinata, dettagli eleganti, possibilità di avvolgere il cavo di alimentazione e impilare il prodotto per ridurre lo spazio necessario per lo stoccaggio: Cabana è un apparecchio mobile da appoggio per esterno che coniuga bellezza formale e praticità. La struttura è realizzata interamente in alluminio trattato mediante cataforesi per aumentare la resistenza alla corrosione e verniciato a polvere epossipoliestere, mentre lo schermo è in polietilene opalino. L'apparecchio è fornito di cavo per esterni da 5 m con spina schuko ed è predisposto per tre lampade con attacco E27, ad esclusione di quelle alogene e ad incandescenza. Il grado di protezione contro la penetrazione di polvere, corpi solidi e liquidi è IP55.

Easily stackable mobile fixture with a stand for outdoors, Cabana is a cheerful yet classy luminaire made entirely of aluminium treated with electrophoresis and coated with UV stabilized epoxy polyester powder to increase resistance to corrosion. Equipped with an opal polyethylene screen, it is designed for 3 lamps with E27 socket, with an exception of halogen and incandescent lamps. The fixture is supplied with a 5m cable for outdoor use with a schuko plug. Its degree of protection against the penetration of dust, solid objects and liquids is IP55.



IP	55
08	Bianco satinato
SL	sorgente luminosa: tornado ES E27

CABANA

CODICE	W
A1-100	3x Max 15

non utilizzare sorgenti alogene o ad incandescenza
do not use halogen or incandescent lamps

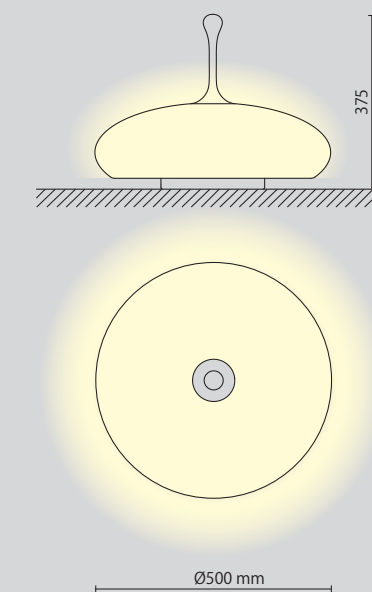



HAIKU

ESTERNO / OUTDOOR

Sottile, sobrio e versatile, grazie allo snodo che permette di regolare l'inclinazione del flusso luminoso, Haiku è un apparecchio da esterno con corpo in alluminio pressofuso trattato a polvere con vernice epossipoliestere resistente ai raggi UV e schermo di protezione in policarbonato microprismato. Disponibile nelle versioni Piccolo o Grande, Haiku è fornito di 20 LED da 230V e il suo grado di protezione contro la penetrazione di polvere, corpi solidi e liquidi è IP55.

Thin, essential and adjustable, Haiku is an outdoor fixture made of die-cast aluminium coated with UV stabilized epoxy polyester powder. Available in two versions, it is furnished with a micro-prismatic polycarbonate screen and 20 LED lights for a total of 230V. Its degree of protection against the penetration of dust, solid objects and liquids is IP55.

HAIKU PICCOLO



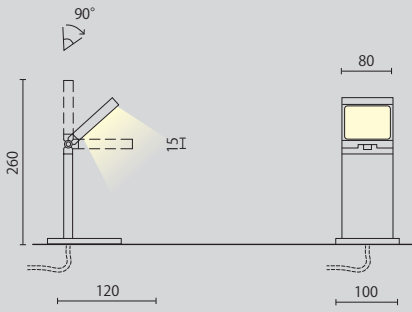



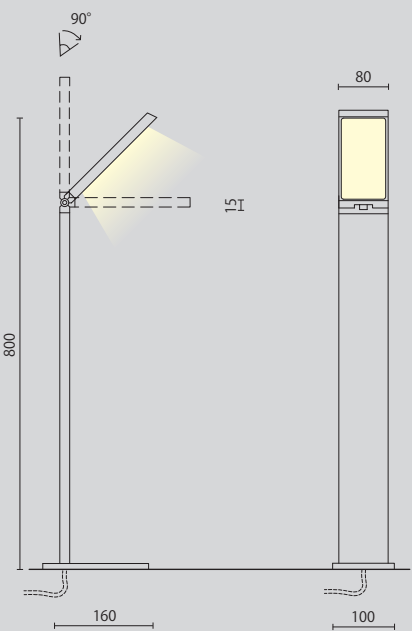

CODICE	W	Lm (3000K)
A1-606...	4	360



HAIKU GRANDE

CODICE	W	Lm (3000K)
A1-607.09...	9	780



-  100°
-  TC 3000K / 4000K
-  IP 55
-  CRI >80
-  EEL A
-  RG 1
-  04 Nero manganese
-  22 Grigio
-  27 Ruggine









OYS

ESTERNO / OUTDOOR

Proiettore da esterno dalla struttura compatta e dalle dimensioni ridotte, Oys ha il corpo in alluminio trattato a polvere con vernice epossipoliestere resistente ai raggi UV. Equipaggiato con sorgente luminosa a LED, lente e schermo in vetro trasparente, può essere collegato direttamente alla fonte di alimentazione grazie al driver incorporato nell'apparecchio. Il suo grado di protezione contro la penetrazione di polvere, corpi solidi e liquidi è IP65.

Oys is a small and compact outdoor spotlight made from epoxy polyester powder coated aluminium stabilized at UV rays. It is complete with lens, transparent glass diffuser and LED light source. Thus being tiny, this product has an inner driver which allows it to be directly connected to the power source. Its degree of protection against the penetration of dust, solid objects and liquids is IP65.

-  25°
-  TC 3000K / 4000K
-  IP 65
-  CRI >80
-  EEI A+
-  RG 1
-  02 Nero opaco

CODICE	W	Lm (3000K)
A1-608.03...	3	170

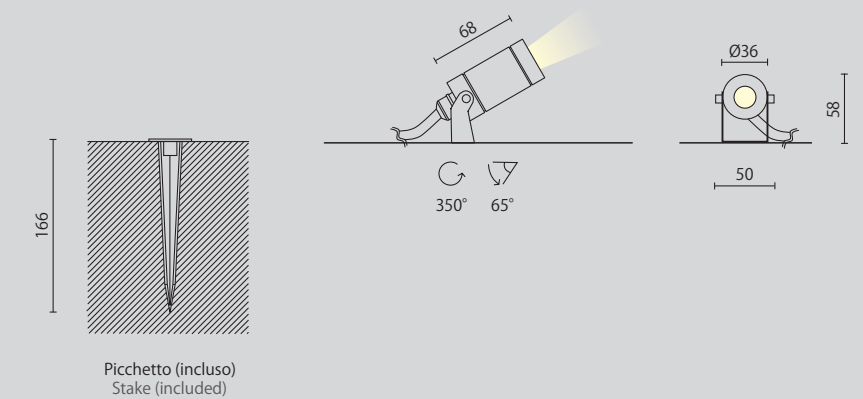



	80°
TC	3000K / 4000K
IP	67
CRI	>80
EEI	A+
RG	0
26	Grigio titanio
IK	07
D	Driver remoto incluso Remote driver included

PLEUS

ESTERNO / OUTDOOR

Forma allegra per Pleus, segnapasso calpestabile e carrabile da esterno disponibile sia mono sia bi-emissione. Il corpo è realizzato in alluminio pressofuso, mentre la cassaforma è in tecnopolimeri ad alta resistenza. Pleus ha il diffusore in metacrilato ed è equipaggiato con sorgente LED e driver remoto. Il grado di protezione contro la penetrazione di polvere, corpi solidi e liquidi è IP67.

Pleus is a sprightly walkable/passable outdoor step light available both single and double emission. It has a die-cast aluminium body, a high resistance technopolymer flush box and a methacrylate diffuser. Pleus is complete with LED light sources and remote driver. Its degree of protection against the penetration of dust, solid objects and liquids is IP67.

PLEUS MONOEMISSIONE

CODICE	W	Lm (3000K)
A1-655.1...	3	40

controcassa inclusa / flush box included

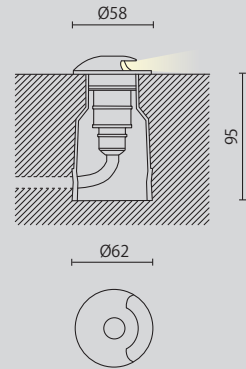

PLEUS BIEMISSIONE

CODICE	W	Lm (3000K)
A1-655.2...	3	60

controcassa inclusa / flush box included

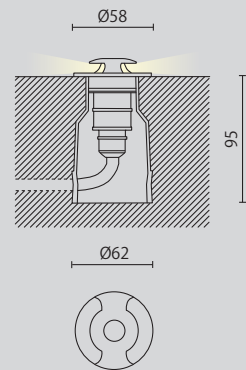



JAGO

ESTERNO / OUTDOOR

Caratterizzato dalla ghiera tonda in acciaio inox, Jago è un apparecchio da incasso per esterni. Il corpo è realizzato in tecnopolimeri ad alta resistenza, mentre la controcassa è in nylon 66 FV 30% (da ordinare separatamente). Jago ha il diffusore in vetro temprato spessore 12 mm, con carico statico pari a 2000 Kg e temperatura in superficie di 40°C. Equipaggiato con scheda elettronica a LED da 230V, non necessita di driver. Il grado di protezione contro la penetrazione di polvere, corpi solidi e liquidi è IP67.

Identified by a circular stainless steel trim, Jago is an outdoor recessed fixture with a highly resistant technopolymer housing, a 66 30% FV nylon outer casing (not included) and a 12mm tempered glass diffuser with a static capacity of 2000 Kg and a surface temperature of 40°C. Equipped with a LED module for a total of 230V, it does not request a driver. Its degree of protection against the penetration of dust, solid objects and liquids is IP67.

	100°
TC	3000K / 4000K
IP	67
CRI	>80
EEL	A+
RG	0
23	Acciaio
IK	10

CODICE	W	Lm (3000K)
A1-620.04...	4	360
0500	cassaforma in nylon obbligatoria (esclusa) nylon flush box requested (not included)	

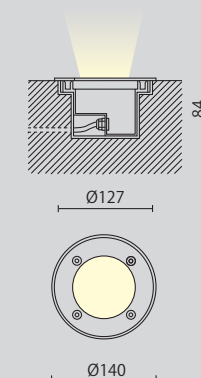

DATI TECNICI

TECHNICAL DATA

COLORI / COLOURS

02	Nero opaco <i>Matt black</i>
03	Nero lucido <i>Glossy black</i>
04	Nero manganese <i>Manganese black</i>
05	Nero anodizzato <i>Anodized black</i>
08	Bianco satinato RAL 9003 <i>Frosted white RAL 9003</i>
09	Bianco opaco RAL 9010 <i>Matt white RAL 9010</i>
13	Oro <i>Gold</i>
14	Cromato <i>Chrome</i>
16	Bronzo anodizzato <i>Anodized bronze</i>
20	Anodizzato naturale <i>Anodized natural</i>
22	Grigio RAL 9006 <i>Grey RAL 9006</i>
23	Acciaio <i>Steel</i>
26	Grigio titanio <i>Titanium grey</i>
27	Ruggine <i>Rust</i>
29	Bronzo metallizzato <i>Metalized bronze</i>
38	Grigio antracite <i>Charcoal grey</i>
46	Rovere sbiancato <i>Whitened durmast</i>

Le caratteristiche tecniche degli articoli potranno subire variazioni senza preavviso ed obbligo di comunicazione, secondo le nostre esigenze di fabbricazione e per il perfezionamento degli apparecchi.

The technical specifications of all products can be altered immediately without prior notice in order to comply with our manufacturing requirements and to improve the specification of the products

IP

Grado di protezione.
Protection degree.

Protezione contro la penetrazione di corpi solidi. *Protection against penetration of solid object.*

1° cifra 1st numeral	Descrizione Description	Simbolo Symbol
0	Non protetto / Non-protected	
1	Protetto da solidi di diametro superiore a 50 mm <i>Protected against solid objects up to than 50 mm</i>	
2	Protetto da solidi di diametro superiore a 12 mm <i>Protected against solid objects up to than 12 mm</i>	
3	Protetto da penetrazione di sonda con Ø2,5 mm <i>Protected against solid objects with Ø 2,5 mm</i>	
4	Protetto da penetrazione di sonda con Ø1 mm <i>Protected against solid objects with Ø 1 mm</i>	
5	Protetto dall'ingresso della polvere / <i>Dust-protected</i>	
6	Stagno alla polvere / <i>Dust-tight</i>	

Protezione contro la penetrazione di liquidi. *Protection against penetration of water.*

2° cifra 2nd numeral	Descrizione Description	Simbolo Symbol
0	Non protetto / Non-protected	
1	Protetto da caduta verticale di gocce d'acqua / <i>Protected against dripping water</i>	
2	Protetto da caduta di gocce d'acqua con involucro inclinato max di 15° <i>Protected against dripping water when tilted up to 15°</i>	
3	Protetto da pioggia / <i>Protected against spraying water</i>	
4	Protetto dagli spruzzi d'acqua / <i>Protected against splashing</i>	
5	Protetto dai getti d'acqua / <i>Protected against water jets</i>	
6	Protetto dalle ondate / <i>Protected against heavy seas</i>	
7	Stagno alle immersioni / <i>Protected against the effects of immersion</i>	
8	Stagno alla sommersione / <i>Protected against submersion</i>	

CLASSE / CLASS

Grado di protezione contro la scossa elettrica / *Degree of protection against electric shocks.*

Classe Class	Descrizione Description	Simbolo Symbol
0	La protezione si basa sull'isolamento fondamentale. Non è previsto il conduttore di protezione (massa a terra). <i>Protection is achieved by simple insulation, there is no earth cable provided.</i>	Nessun simbolo <i>No symbol</i>
I	La protezione si basa sull'isolamento fondamentale e sul collegamento delle pareti metalliche accessibili ad un conduttore di protezione (massa a terra). <i>The protection is achieved by simple insulation and connection of all metallic components to an earth wire protection cable.</i>	Nessun simbolo <i>No symbol</i>
II	La protezione si basa sull'isolamento fondamentale e su misure supplementari quali il doppio isolamento rinforzato. <i>Protection is achieved by simple insulation and some other devices such as double insulation or reinforced insulation. There is no earth cable provided.</i>	
III	La protezione si basa sul fatto che in ogni punto dell'apparecchio la tensione di alimentazione e/o di funzionamento è inferiore a 50V valore efficace in C.A. (bassissima tensione di sicurezza). <i>Protection is achieved by every component of the luminaire having a start/functioning voltage of less than 50 VA (safety Extra Low Voltage SELV).</i>	

IK

Grado di protezione.
Protection degree.

Protezione contro gli impatti meccanici esterni. *Protection against external mechanical impacts.*

Cifra carattere Numeral	Descrizione Description
00	Non protetto / Non-protected
01	Protetto contro un urto di energia 0,15 J / <i>Protected against impact energy 0,15 J</i>
02	Protetto contro un urto di energia 0,2 J / <i>Protected against impact energy 0,2 J</i>
03	Protetto contro un urto di energia 0,35 J / <i>Protected against impact energy 0,35 J</i>
04	Protetto contro un urto di energia 0,5 J / <i>Protected against impact energy 0,5 J</i>
05	Protetto contro un urto di energia 0,7 J / <i>Protected against impact energy 0,7 J</i>
06	Protetto contro un urto di energia 1 J / <i>Protected against impact energy 1 J</i>
07	Protetto contro un urto di energia 2 J / <i>Protected against impact energy 2 J</i>
08	Protetto contro un urto di energia 5 J / <i>Protected against impact energy 5 J</i>
09	Protetto contro un urto di energia 10 J / <i>Protected against impact energy 10 J</i>
10	Protetto contro un urto di energia 20 J / <i>Protected against impact energy 20 J</i>

DRIVER

Driver in tensione continua.
Driver Vdc.

	Codice Code	W	IP	Dimensioni Dimensions (LxWxH)	
12Vdc	0700	4	40	52x27x21 mm	
	0730	20	67	118x35x26 mm	
	0731	35	67	148x40x30 mm	
	0732	60	67	163x43x32 mm	
	24Vdc	0733	100	67	190x52x37 mm
		0734	150	67	191x67x38 mm
0735		185	67	229x68x39 mm	
0736		240	67	251x68x39 mm	
24Vdc DIMM	0731/DIMM 2-3	35	20	195x43x30 mm	
	0732/DIMM 2-3	60	20	225x43x30 mm	
	0733/DIMM 2-3	100	20	295x43x30 mm	
	0734/DIMM 2-3	150	20	325x43x30 mm	

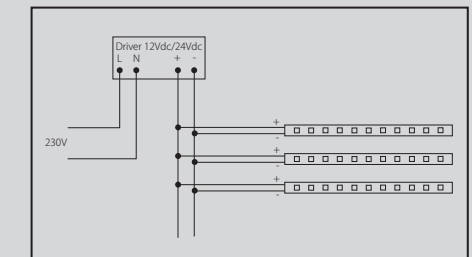

DATI TECNICI

TECHNICAL DATA

EMERGENZA: INVERTER E BATTERIE PER LED / EMERGENCY: LED INVERTERS AND BATTERIES

Codice Code		
0800/EM	Max 30W	Output 9-58V

Unità d'emergenza ad uso indipendente multipotenza regolabile tramite dip-switch, per power LED a corrente costante o per moduli LED a tensione costante.

Possibilità di funzionamento in sola emergenza (SE) o tipo SA in abbinamento ad un driver con tensione in uscita max 90V e corrente max 2A.

Autonomia 1h.

Dimensioni: inverter mm 52x156xh26; batterie mm 135x45xh25.

Avvertenze:
PER NON DANNEGGIARE I LED COLLEGARE NELL'ORDINE:
1) SORGENTE LED;
2) CAVO BATTERIA;
3) ALIMENTAZIONE DI RETE.
NON SCOLLEGARE E RICOLLEGARE I LED CON EMERGENZA IN FUNZIONE.

Multi-voltage emergency unit to be used independently. Adjustable by dip-switch. For constant current power LEDs or for constant voltage LED modules.

Can be used in either emergency only (SE) mode or SA (always on) mode, combined with a driver with maximum 90V output voltage and maximum 2A current.

Autonomy 1 hour.

Dimensions: inverters 52mm x 156mm x h26mm; batteries 135mm x 45mm x h25mm

*Warning:
TO AVOID DAMAGING LEDS CONNECT THEM IN THE FOLLOWING ORDER:
1) LED SOURCE;
2) BATTERY CABLE;
3) GRID POWER SUPPLY.
DO NOT DISCONNECT AND RECONNECT LEDS IN EMERGENCY MODE.*

DIMMER PER DRIVER LED 24Vdc / DIMMER FOR 24Vdc DRIVER

Codice Code	
0800/DIM	Max 250W

Regolatore di luminosità per driver LED in tensione 12Vdc-24Vdc.
Modalità di funzionamento DALI, Push, 1-10V, 0-10V.
La modalità di funzionamento è selezionata attraverso DIP SWITCH.

Tensione di alimentazione: 12Vdc - 24Vdc
Corrente massima di uscita: 12A.
Dimensioni DIMM: 156x52xh26mm

*Light regulator for 12Vdc-24Vdc LED driver.
DALI, Push, 1-10V, 0-10V mode of operation.
Mode of operation selection by DIP SWITCH.*

*Voltage: 12Vdc - 24Vdc
Maximum current output: 12A.
Dimensions: 156x52xh26 mm*

DATI TECNICI

TECHNICAL DATA

DRIVER - CORRENTE CONTINUA NON DIMMERABILI IP20 / DRIVER - DIRECT CURRENT NOT DIMMABLE IP20

Codice Code	Potenza Wattage	Corrente Currente	Tensione (min-max) Voltage
0310.10CC350	10W	350mA	13-26V
0310.20CC350	20W	350mA	26-57V
0310.35CC350	35W	350mA	50-100V

0310.10CC500	10W	500mA	9-20V
0310.20CC500	20W	500mA	18-40V
0310.35CC500	35W	500mA	35-70V

0310.10CC700	10W	700mA	6,5-14,5V
0310.20CC700	20W	700mA	13-29V
0310.30CC700	30W	700mA	32-40V

0310.42CC900	42W	900mA	23-47V
--------------	-----	-------	--------

0310.35CC1050	35W	1050mA	16,5-33,5V
0310.42CC1050	42W	1050mA	20-40V
0310.60CC1050	60W	1050mA	31-57V

0310.65CC1400	65W	1400mA	23-46,5V
---------------	-----	--------	----------

Avvertenze:

- Prima di acquistare un driver in corrente continua, onde evitare malfunzionamenti o danni irreparabili alle sorgenti a LED, è necessario verificare che la tensione nominale del LED utilizzato (se più LED collegati in serie la loro somma) sia compresa nel range dei valori di tensione del driver;

- Collegamenti: dare tensione solo dopo aver cablato correttamente il LED ai morsetti polarizzati (+-) del driver, in quanto il picco di tensione in uscita di un driver c.c. senza carico è maggiore del valore massimo riportato nei relativi dati. Per evitare danni alle sorgenti luminose, non collegare mai un LED ad un driver c.c. alimentato.

Per eventuali richieste di driver dimmerabili, contattare i nostri uffici commerciali.

Warning:

- Before purchasing a direct current driver, in order to avoid malfunctioning or irreparable damage to LED sources, you must check that the nominal voltage of the LED used (in the case of a series of connected LEDs then calculate their sum) is within the range of the rated voltage of the driver.

- Connections: apply power only after correctly cabling the LED to the polarised (+ -) terminals of the driver as the peak of output voltage of an uncharged direct current driver is greater than the maximum value stated in the relative specifications. To avoid damaging light sources, never mount a LED on a powered direct current driver.

If you require dimmerable drivers contact our sales office.

DIMM2

Dali
Dali

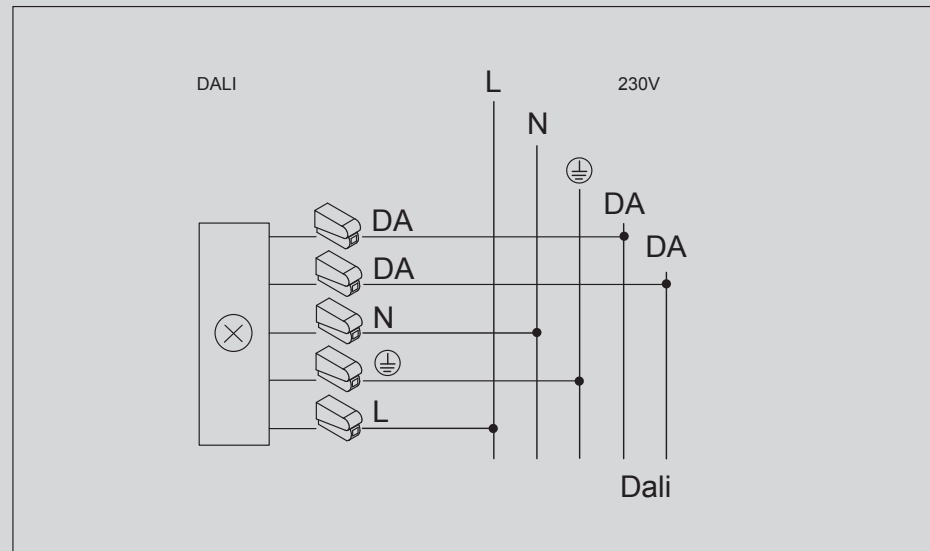

Digitale (Versione dimmerabile con protocollo DALI).
Digital (Dimmer version with DALI protocol).

Gestione digitale DALI.

Il protocollo DALI (Digital Addressable Lighting Interface) è uno standard per alimentatori elettronici dimmerabili che offre funzionalità e facilità d'uso. Con una linea di controllo a due fili è possibile controllare con un'elevata versatilità 64 alimentatori elettronici DALI, assegnare 16 gruppi e programmare sino a 16 scenari luminosi. La commutazione e il dimming sono gestiti dalla linea di controllo e non necessita di relè. Le informazioni importanti come lo stato delle lampade sono memorizzate nell'alimentatore e restano a disposizione del controller. Un nuovo conferimento dei gruppi può essere realizzato in qualsiasi momento senza la necessità di effettuare nuovi cablaggi costosi, ad esempio a seguito di un restauro o un cambiamento di utilizzo di un locale. Riassumendo, progettare ed installare un impianto DALI significa avere un'unica linea di controllo a due cavi per 64 apparecchi. I gruppi degli apparecchi d'illuminazione non devono essere necessariamente assegnati in fase di progettazione ma possono essere configurati successivamente con l'ausilio di un controller. La progettazione della linea dimming può essere di conseguenza completamente separata dalla progettazione delle linee di alimentazione. La linea di controllo non ha polarità e può essere posata insieme all'alimentazione, ad esempio in un cavo a 5 fili. È sufficiente che la linea di controllo sia dimensionata per la tensione della linea e non è necessario un cablaggio speciale. I gruppi degli apparecchi d'illuminazione non sono collegati direttamente; i singoli apparecchi vengono raggruppati semplicemente assegnandoli a gruppi con l'ausilio di un controller.

Digital control DALI.

The DALI (Digital Addressable Lighting Interface) is a protocol for dimmable electronic ballast which is functional and easy to use. With a two-wire differential bus you can handily control 64 DALI electronic ballasts, assign up to 16 groups and programme up to 16 lighting scenarios. Commutation and dimming are handled by the control wire and do not require a relay. Important information such as the state of the lamps is memorised in the ballast and is constantly accessible to the controller. Groups can be differently assigned at any time without the need for any costly new wiring, for instance following a home renovation. In short designing and installing a DALI plant means having a single control wire with a two-wire bus for up to 64 devices. The groups of lighting fixtures do not necessarily have to be assigned during the planning phase but can be configured later with the aid of a controller. The design of the dimming wire can consequently be completely separate from the power cable design. The control wire is non-polarised and can be routed together with the ballast, for example in a 5 conductor cable. The control wire only needs to be adjusted for mains voltage and does not necessitate special wiring. The groups of lighting fixtures are not connected directly. Individual fixtures are grouped simply by assigning them to groups with the aid of a controller.

DIMM3

Switch-DIM
Switch-DIM

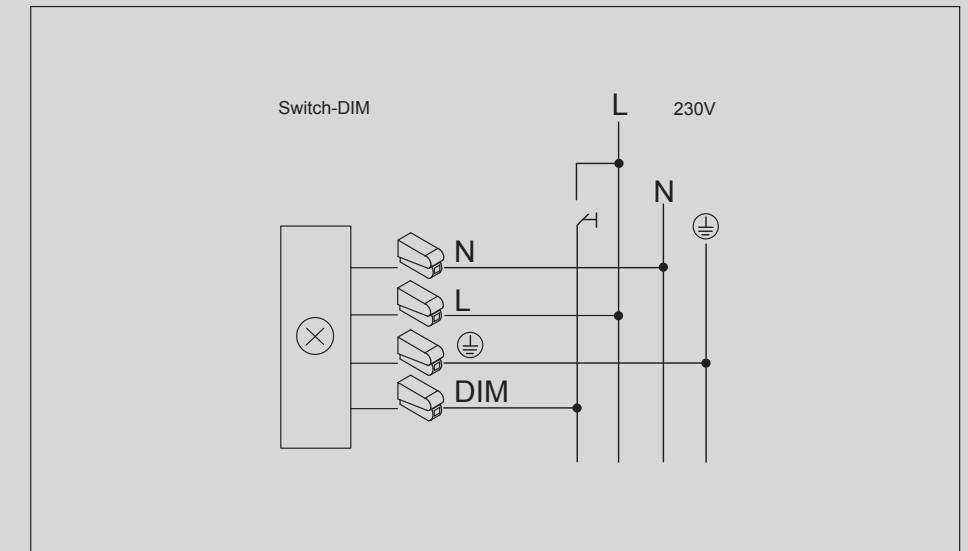

Digitale (Versione dimmerabile tramite un semplice pulsante con contatti normalmente aperti switch/dim).
Digital (Dimmer version with switch/dim).

Gestione digitale switchDim.

Le applicazioni switchDIM utilizzano la tensione di rete come segnale di regolazione per alimentatori digitali dimmerabili. Rappresentano la forma più semplice di gestione del flusso luminoso per le piccole e medie installazioni e rendono la tecnologia switchDIM estremamente semplice, dall'ottimo rapporto qualità/prezzo e dal facile uso. La dimmerazione, così pure l'accensione e lo spegnimento del sistema luminoso, possono essere effettuati da svariati punti semplicemente utilizzando pulsanti N/A commerciali convenzionali, collegati alla tensione di rete. I reattori elettronici utilizzati da Aqlus sono dotati di memoria e mantengono l'ultimo valore di luminosità selezionato anche in caso di interruzione di rete. Modalità d'uso: l'accensione e lo spegnimento dell'apparecchio è effettuato tramite rapida pressione del pulsante, mentre per la regolazione up/down del flusso luminoso si rende necessaria una pressione prolungata. Un pulsante può comandare sino a 20 alimentatori elettronici (contattare i nostri uffici per maggiori dettagli). In caso di perdita del sincronismo tra le varie lampade, gli apparecchi potranno essere nuovamente sincronizzati tenendo premuto il pulsante che le comanda, per una decina di secondi.

SwitchDIM digital control.

SwitchDIM applications use mains voltage as a control signal for digital dimmable ballasts. They are the simplest way of controlling brightness in small and medium sized installations and make switchDim technology extremely simple and user-friendly with an excellent quality/price ratio. Dimming, like switching the light on and off, can be done from various points simply by using conventional commercial N/A switches connected with mains voltage. The ballasts used by Aqlus are equipped with a memory and memorise the last brightness value selected even in the case of a power cut. Instructions for use: the fixture is switched on and off by rapidly pushing the button while fade up/down control requires the button to be held down for a longer time. A switch-dim can control up to 20 electronic ballasts (for more informations contact our offices). In case of loss of synchronism between different lamps the fixtures can again be synchronised by keeping the button held down for approximately ten seconds.

EM

Emergenza
Emergency

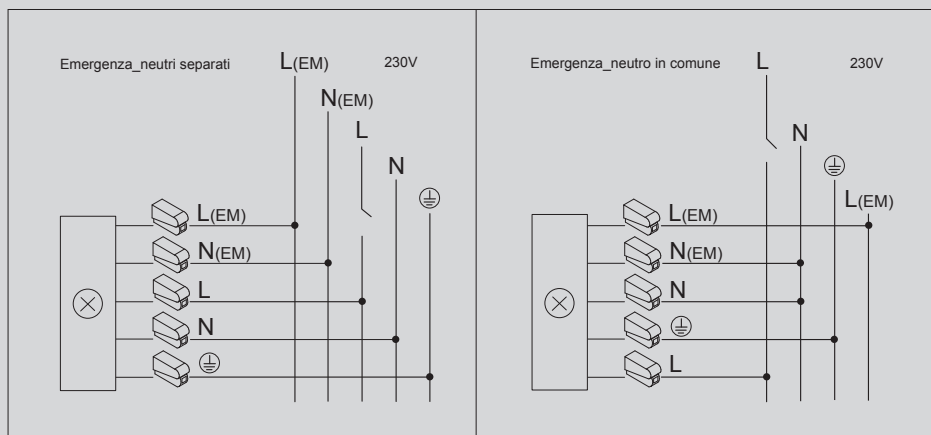

Versioni emergenza complete di inverter e gruppo batterie; luce permanente, autonomia 1 ora.
Emergency versions complete with an inverter and a battery unit; permanent light, autonomy 1 hour.

Funzionamento in emergenza

Le lampade di emergenza forniscono un'illuminazione fondamentale quando vi è un'improvvisa mancanza d'erogazione dell'energia elettrica a seguito di guasti, sgancio imprevisto degli interruttori automatici di protezione ed in caso di situazioni di pericolo. Lo scopo è assicurare un adeguato grado di illuminamento in modo da garantire le operazioni in tutte le situazioni di rischio. L'illuminazione di emergenza è quindi, soprattutto nelle situazioni più gravi, una componente fondamentale per la sicurezza delle persone. I luoghi che devono essere obbligatoriamente dotati di illuminazione di emergenza sono indicati dalle varie normative e dai DM vigenti. L'uso è prescritto per tutti i luoghi solitamente affollati come ospedali, scuole, luoghi di lavoro, cinema ecc...

Da non sottovalutare inoltre anche l'ambito domestico, dove l'illuminazione di emergenza può assumere un ruolo fondamentale per la sicurezza delle persone. Per scegliere correttamente le lampade di emergenza è necessaria la conoscenza delle varie tipologie e caratteristiche fondamentali dei vari tipi di funzionamento. Tutti gli apparecchi Aqlus dotati di inverter e batteria sono di tipo SA (funzionamento permanente) e cioè la lampada rimane costantemente accesa sia in presenza che in assenza di rete; questo tipo di funzionamento è normalmente richiesto per l'illuminazione delle vie di esodo. Inoltre questa tipologia è comunemente utilizzata nei locali dove non è possibile aggiungere ulteriori punti luce. Infatti, con un unico apparecchio si gestisce sia l'illuminazione ordinaria (on/off) che quella di emergenza.

Le altre tipologie esistenti sono:

- Apparecchi non permanenti di tipo SE: la lampada si accende solo quando c'è un'interruzione dell'energia elettrica.
- Modelli SL: gli apparecchi non sono dotati di pacchi batterie e di inverter ma soltanto dell'alimentatore/driver per l'accensione della sorgente luminosa. Possono essere alimentati da una tensione di 230Vac ed utilizzati come funzionamento ordinario, oppure possono essere collegate ad impianti di emergenza con soccorritore centralizzato.

L'autonomia minima garantita dei prodotti in emergenza forniti da Biffi Luce è pari a 1h di funzionamento ma a richiesta (ove è possibile) possono essere prodotti con un'autonomia di 2h o 3h.

Emergency lighting

Emergency lighting provides basic lighting when there is a sudden blackout due to electrical failure or tripped switches and in situations of danger. Its purpose is to guarantee a sufficient degree of illumination so as to ensure operations in all cases of risk. Emergency lighting is, therefore, above all in the most serious situations, a fundamental safety component. Places which must be provided with emergency lighting are listed in the various regulations and laws in force. Its use is mandatory in all normally crowded environments such as hospitals, schools, workplaces, cinemas etc... Moreover, the home, where emergency lighting may be key to peoples' safety, should not be overlooked.

In order to choose the correct types of emergency lighting it is necessary to know them and understand how they work.

All Aqlus fixtures equipped with an inverter and battery are SA type (providing permanent lighting) meaning that the light stays on whether or not it is connected to the mains. Lighting with this feature is normally used to light emergency exits. Moreover, this type is usually found in places where it is not possible to add any more light sources. Indeed, just one fixture provides ordinary (on/off) and emergency lighting.

Other existing types are:

- *Non-permanent SE type fixtures: the light only goes on when there is an outage.*
- *SL models: the fixtures are not supplied with battery packs and inverters but only with a ballast/driver to drive the light source. They may be charged with a voltage of 230V ac and used as ordinary lighting or connected to emergency central power supply systems.*

Minimum operating time guaranteed by emergency products supplied by Biffi Luce is 1 hour but products with 2 or 3 hour operating time can also be ordered (if available).

SICUREZZA FOTOBIOLOGICA / PHOTOBIOLOGICAL SAFETY (RG)

Sicurezza fotobiologica della lampade e dei sistemi per l'illuminazione generale dei dispositivi a LED.

Siamo passati dalle lampade ad incandescenza, ormai obsolete e sostituite dalle lampadine alogene e fluorescenti, per arrivare alle nuove tecnologie LED; questo sviluppo ha inevitabilmente portato alla nascita di numerose nuove normative. La nuova norma IEC/EN 62471 "Sicurezza fotobiologica delle lampade e dei sistemi di lampada" fornisce le linee guida per la valutazione e il controllo dei rischi fotobiologici, specificando le grandezze radiometriche da misurare per valutare i rischi per la pelle e l'occhio umano derivanti dall'esposizione alla luce emessa dagli apparecchi di illuminazione che utilizzano la tecnologia LED. I valori limite sono calcolati in base al tempo di esposizione; nel caso degli apparecchi d'illuminazione, a meno che il compito lavorativo non preveda di fissare la sorgente luminosa, la visione è casuale ed avviene normalmente in maniera accidentale. La versione Europea è armonizzata ai sensi della direttiva 2006/95/CE – Bassa Tensione, di conseguenza, i prodotti elettrici che incorporano LED e che rientrano nel campo di applicazione della Direttiva Bassa Tensione devono soddisfare i requisiti indicati dalla norma EN 62471. Questa Norma classifica in base al grado di pericolosità della radiazione, gli apparecchi di illuminazione in quattro "gruppi di rischio" (assenza/basso/moderato/alto). Sotto riportiamo la tabella riassuntiva di classificazione del rischio fotobiologico delle lampade secondo lo standard CEI EN 62471:2009.

Photobiological safety of lamps and lamp system.

We have passed from incandescent lamps, now obsolete and replaced by halogen and fluorescent lamps, to new LED technologies. This advancement has inevitably led to the emergence of numerous further standards. The new IEC/EN 62471 "Photobiological safety of lamps and lamp systems" standard lays down guidelines for the evaluation and control of photobiological hazards, specifying the types of radiant energy to be measured in order to evaluate the risk to human skin and eyes posed by exposure to light emitted by lighting appliances using LED technologies. Limit values are calculated on the basis of exposure time. In the case of lighting appliances, if the task to be performed does not demand a fixed light source, the vision is random and normally accidental. The European standard is set pursuant to and in accordance with Low Voltage Directive 2006/95/CE. Consequently, electrical products incorporating LED and to which the Low Voltage Directive applies must conform to requirements specified in standard EN 62471. This standard divides lighting appliances into four "risk groups" (exempt/low/moderate/high) based on the degree of radiation hazard. Below is a table summarising the photobiological risk classification of lamps in accordance with standard CEI EN 62471:2009.

Gruppo Group	Descrizione Description
0 (esente/exempt)	Quando non si prevede nessun rischio ottico, anche per un uso continuo e illimitato. <i>Where no optical hazard is considered foreseeable, even for continuous, unrestricted use.</i>
1	Prodotti che sono sicuri per la maggior parte delle applicazioni di utilizzo, fatta eccezione per esposizioni molto prolungate dove possono essere previste esposizioni oculari dirette. <i>Products are safe for most use applications, except for very prolonged exposures where direct ocular exposures may be expected.</i>
2	Prodotti che generalmente non rappresentano un rischio ottico realistico se le reazioni di avversione limitano la durata dell'esposizione o quando esposizioni lunghe non sono realistiche. <i>Products generally do not pose a realistic optical hazard if aversion responses limit the exposure duration or where lengthy exposures are unrealistic.</i>
3	Prodotti che presentano un potenziale pericolo anche per esposizioni momentanee e quando i requisiti di sicurezza del sistema sono essenziali. <i>Products pose a potential hazard even for momentary exposures and system safety requirements are generally essential.</i>

DATI TECNICI

TECHNICAL DATA

APPLICAZIONI A BINARIO / TRACK INSTALLATION

Installazione porta peso.

Il binario può portare un carico di 2 kg ogni 200 mm con una distanza massima fra i punti di fissaggio di 1000 mm.
Nel caso di 5 kg ogni 200 mm la distanza di fissaggio deve essere di 500 mm.

Installation weights.

The track can support a weight of 2 kg every 200 mm with maximum unconnected fixing centres of 1000 mm.
When this rises to 5 kg every 200 mm, the fixing centres must be decreased to 500 mm.

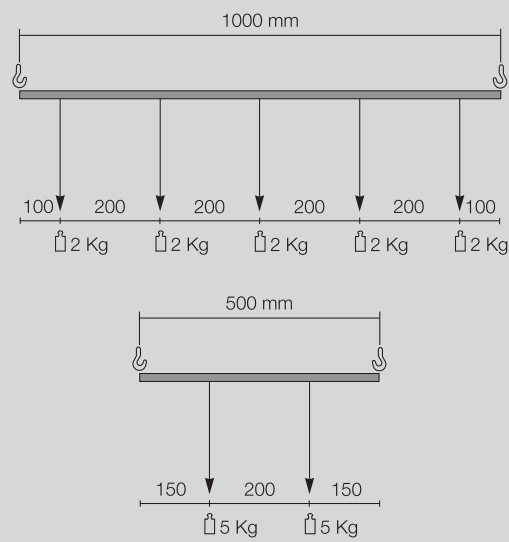

Schema elettrico trifase.

Tensione di esercizio 230/250 V tra una fase e il neutro. Il collegamento della rete elettrica trifase 230/250 V consente un carico di 16A per fase che corrisponde 3680 VA per ogni circuito.

Three-phase electrical diagram.

Supply voltage 230/250 V. Connection to three phase 230/250 V electrical supply enables a total load of 16 amps to be used which corresponds to 11040 VA spread over three circuits (3x3680 VA).

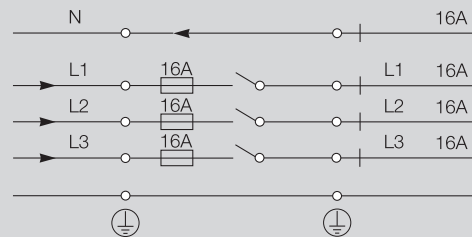

CODICE	P.	CODICE	P.	CODICE	P.
0310.10CC350	303	A1		A2-612.15AC.40/D	92
0310.10CC500	303	A1-100	283	A2-612.17.30/D	92
0310.10CC700	303	A1-606.30	286	A2-612.17.40/D	92
0310.20CC350	303	A1-606.40	286	A2-612.22.30/D	92
0310.20CC500	303	A1-607.09.30	286	A2-612.22.40/D	92
0310.20CC700	303	A1-607.09.40	286	A2-612.31.30/D	92
0310.30CC700	303	A1-608.03.30	289	A2-612.31.40/D	92
0310.35CC1050	303	A1-608.03.40	289	A2-628.17.30/D	104
0310.35CC350	303	A1-620.04.30	295	A2-628.17.40/D	104
0310.35CC500	303	A1-620.04.40	295	A2-628.23.30/D	104
0310.42CC1050	303	A1-655.1.30	292	A2-628.23.40/D	104
0310.42CC900	303	A1-655.1.40	292	A2-629.20AC.30	104
0310.60CC1050	303	A1-655.2.30	292	A2-629.20AC.30/D	104
0310.65CC1400	303	A1-655.2.40	292	A2-629.20AC.40	104
0500	295			A2-629.20AC.40/D	104
0506.1	165	A2		A2-629.30AC.30	104
0700	301	A2-207.30/D	97	A2-629.30AC.30/D	104
07-010	277	A2-207.40/D	97	A2-629.30AC.40	104
0730	277, 301	A2-209.30	94	A2-629.30AC.40/D	104
0731	277, 301	A2-209.30/D	94	A2-640.18.30	110
0731/DIMM2-3	277, 301	A2-209.40	94	A2-640.18.40	110
0732	277, 301	A2-209.40/D	94	A2-642.25.30	110
0732/DIMM2-3	277, 301	A2-604.15AC.30/D	114	A2-642.25.40	110
0733	277, 301	A2-604.15AC.40/D	114	A2-642.30AC.30	110
0733/DIMM2-3	277, 301	A2-606.15.30	98	A2-642.30AC.40	110
0734	277, 301	A2-606.15.30/D	101	A2-642.34.30	110
0734/DIMM2-3	277, 301	A2-606.15.40	98	A2-642.34.40	110
0735	277, 301	A2-606.15.40/D	101	A2-642.38.30	110
0736	277, 301	A2-606.17.30/D	98	A2-642.38.40	110
0800/DIM	210, 244, 248, 252, 257, 263, 268, 274, 302	A2-606.17.40/D	98	A2-644.38.30	110
0800/EM	210, 244, 248, 252, 257, 263, 268, 274, 302	A2-606.23.30/D	98	A2-644.38.40	110
6901	116	A2-606.23.40/D	98	A2-644.40AC.30	110
6902	116	A2-607.08AC.30	97	A2-644.40AC.40	110
6903	116	A2-607.08AC.30/D	100	A2-644.44.30	110
6904	116	A2-607.08AC.40	97	A2-644.44.40	110
6905	116	A2-607.08AC.40/D	100	A2-644.46.30	110
6906	116	A2-608.17.30	113	A2-644.46.40	110
6907	116	A2-608.17.30/D	113		
6908	116	A2-608.17.40	113	A3	
6909	116	A2-608.17.40/D	113	A3-400.30	52
6910	116	A2-609.12.30/D	84	A3-400.40	52
6911	116	A2-609.12.40/D	84		
6912	116	A2-610.08AC.30	87	A4	
6913	116	A2-610.08AC.30/D	87	A4-202.2.30	40
6914	116	A2-610.08AC.40	87	A4-202.2.40	40
6915	116	A2-610.08AC.40/D	87	A4-203.4.30	42
6916	116	A2-612.15AC.30	92	A4-203.4.40	42
6917	116	A2-612.15AC.30/D	92	A4-600.212.30	40
6918	116	A2-612.15AC.40	92	A4-600.212.40	40

CODICE	P.	CODICE	P.	CODICE	P.
A4-600.217.30	40	A5-606.10.40	147	A5-664.22.30	129
A4-600.217.40	40	A5-606.10.40/DIMM 2-3	147	A5-664.22.30/DIMM 2-3	129
A4-600.223.30	40	A5-620.026.30	125	A5-664.28.30	129
A4-600.223.40	40	A5-620.026.30/DIMM 2-3	125	A5-664.28.30/DIMM 2-3	129
A4-602.412.30	42	A5-620.026.30/EM	125	A5-664.33.30	129
A4-602.412.40	42	A5-620.026.40	125	A5-664.33.30/DIMM 2-3	129
A4-602.417.30	42	A5-620.026.40/DIMM 2-3	125	A5-665.07.30	131
A4-602.417.40	42	A5-620.026.40/EM	125	A5-665.07.30/DIMM 2-3	131
A4-602.423.30	42	A5-621.026.30	125	A5-665.10.30	131
A4-602.423.40	42	A5-621.026.30/ EM	125	A5-665.10.30/DIMM 2-3	131
A4-613.30	36	A5-621.026.30/DIMM 2-3	125	A5-666.07.30	131
A4-613.40	36	A5-621.026.40	125	A5-666.07.30/DIMM 2-3	131
A4-630.036.30	49	A5-621.026.40/ EM	125	A5-666.10.30	131
A4-630.036.30/DIMM 2-3	49	A5-621.026.40/DIMM 2-3	125	A5-666.10.30/DIMM 2-3	131
A4-630.036.40	49	A5-628.17.30	107	A5-668.11.30	136
A4-630.036.40/DIMM 2-3	49	A5-628.17.30/DIMM 2-3	107	A5-668.11.30/DIMM 2-3	136
A4-631.048.30	49	A5-628.17.40	107	A5-669.25.30	137
A4-631.048.30/DIMM 2-3	49	A5-628.17.40/DIMM 2-3	107	A5-669.25.30/DIMM 2-3	137
A4-631.048.40	49	A5-628.24.30	107	A5-670.07.30	133
A4-631.048.40/DIMM 2-3	49	A5-628.24.30/DIMM 2-3	107	A5-670.07.30/DIMM 2-3	133
A4-640.13.30	12	A5-628.24.40	107	A5-670.10.30	133
A4-640.13.40	12	A5-628.24.40/DIMM 2-3	107	A5-670.10.30/DIMM 2-3	133
A4-641.15.30	12	A5-629.10.30	139	A5-672.30	123
A4-641.15.40	12	A5-629.10.30/DIMM 2-3	139	A5-672.30/DIMM 2-3	123
A4-641.20.30	12	A5-632.08AC.30	153	A5-672.30/EM	123
A4-641.20.40	12	A5-632.08AC.40	153	A5-672.40	123
A4-645.25.30	12	A5-650.30	165	A5-672.40/DIMM 2-3	123
A4-645.25.40	12	A5-650.60	165	A5-672.40/EM	123
A4-646.35.30	12	A5-651.30	165	A5-673.70.30	123
A4-646.35.40	12	A5-655.30	170	A5-673.70.30/DIMM 2-3	123
A4-650.15.30	27	A5-656.30	170	A5-673.70.30/EM	123
		A5-662.22.30	127	A5-673.70.40	123
A5		A5-662.22.30/DIMM 2-3	127	A5-673.70.40/DIMM 2-3	123
A5-600.03.30	166	A5-662.22.40	127	A5-673.70.40/EM	123
A5-601.03.30	167	A5-662.22.40/DIMM 2-3	127	A5-675.10.30	141
A5-605.07.30	142	A5-662.28.30	127	A5-675.10.30/DIMM 2-3	141
A5-605.07.30/DIMM 2-3	142	A5-662.28.30/DIMM 2-3	127	A5-676.15.30	140
A5-605.07.40	142	A5-662.28.40	127	A5-676.15.30/DIMM 2-3	140
A5-605.07.40/DIMM 2-3	142	A5-662.28.40/DIMM 2-3	127	A5-677.07.30	157
A5-605.10.30	142	A5-662.33.30	127	A5-677.07.30/DIMM 2-3	157
A5-605.10.30/DIMM 2-3	142	A5-662.33.30/DIMM 2-3	127	A5-677.12.30	157
A5-605.10.40	142	A5-662.33.40	127	A5-677.12.30/DIMM 2-3	157
A5-605.10.40/DIMM 2-3	142	A5-662.33.40/DIMM 2-3	127	A5-678.07.30	149
A5-606.07.30	147	A5-663.22.30	129	A5-678.07.30/DIMM 2-3	149
A5-606.07.30/DIMM 2-3	147	A5-663.22.30/DIMM 2-3	129	A5-678.07.40	149
A5-606.07.40	147	A5-663.28.30	129	A5-678.07.40/DIMM 2-3	149
A5-606.07.40/DIMM 2-3	147	A5-663.28.30/DIMM 2-3	129	A5-678.10.30	149
A5-606.10.30	147	A5-663.33.30	129	A5-678.10.30/DIMM 2-3	149
A5-606.10.30/DIMM 2-3	147	A5-663.33.30/DIMM 2-3	129	A5-678.10.40	149

CODICE	P.	CODICE	P.	CODICE	P.
A5-678.10.40/DIMM 2-3	149	A6-019.3	184, 210, 236	A6-604P.140.40/DIMM 2-3	214
A5-679.12.30	151	A6-019.4	184, 210, 236	A6-604P.140.40/EM	214
A5-679.12.30/DIMM 2-3	151	A6-019.5	184, 210, 236	A6-604P.168.30	214
A5-679.12.40	151	A6-021	236	A6-604P.168.30/DIMM 2-3	214
A5-679.12.40/DIMM 2-3	151	A6-028	248, 252, 257	A6-604P.168.30/EM	214
A5-679.18.30	151	A6-029	248, 252, 257	A6-604P.168.40	214
A5-679.18.30/DIMM 2-3	151	A6-030	252	A6-604P.168.40/DIMM 2-3	214
A5-679.18.40	151	A6-031	244	A6-604P.168.40/EM	214
A5-679.18.40/DIMM 2-3	151	A6-032	244	A6-604P.196.30	214
A5-680.07.30	135	A6-033	244	A6-604P.196.30/DIMM 2-3	214
A5-680.07.30/DIMM 2-3	135	A6-036	184, 210	A6-604P.196.30/EM	214
A5-680.12.30	135	A6-037	210	A6-604P.196.40	214
A5-680.12.30/DIMM 2-3	135	A6-038	210	A6-604P.196.40/DIMM 2-3	214
A5-680.15.30	135	A6-039	210	A6-604P.196.40/EM	214
A5-680.15.30/DIMM 2-3	135	A6-040	210	A6-604P.224.30	214
A5-681.07.30	154	A6-045	184	A6-604P.224.30/DIMM 2-3	214
A5-681.07.30/DIMM 2-3	154	A6-047	184	A6-604P.224.30/EM	214
A5-681.10.30	154	A6-048PL.2.30	184	A6-604P.224.40	214
A5-681.10.30/DIMM 2-3	154	A6-048PL.2.30/DIMM 2-3	184	A6-604P.224.40/DIMM 2-3	214
A5-682.07.30	154	A6-048PL.2.40	184	A6-604P.224.40/EM	214
A5-682.07.30/DIMM 2-3	154	A6-048PL.2.40/DIMM 2-3	184	A6-604P.252.30	214
A5-682.10.30	154	A6-048PL.30	184	A6-604P.252.30/DIMM 2-3	214
A5-682.10.30/DIMM 2-3	154	A6-048PL.30/DIMM 2-3	184	A6-604P.252.30/EM	214
A5-685.07.30	160	A6-048PL.40	184	A6-604P.252.40	214
A5-685.10.30	160	A6-048PL.40/DIMM 2-3	184	A6-604P.252.40/DIMM 2-3	214
A5-686.07.30	160	A6-048S.2.30	184	A6-604P.252.40/EM	214
A5-686.10.30	160	A6-048S.2.30/DIMM 2-3	184	A6-604P.280.30	214
A5-687.07.30	161	A6-048S.2.40	184	A6-604P.280.30/DIMM 2-3	214
A5-687.10.30	161	A6-048S.2.40/DIMM 2-3	184	A6-604P.280.30/EM	214
A5-688.07.30	161	A6-048S.30	184	A6-604P.280.40	214
A5-688.10.30	161	A6-048S.30/DIMM 2-3	184	A6-604P.280.40/DIMM 2-3	214
A5-692.30	122	A6-048S.40	184	A6-604P.280.40/EM	214
A5-692.30/DIMM 2-3	122	A6-048S.40/DIMM 2-3	184	A6-604PL.084.30	214
A5-692.30/EM	122	A6-604P.084.30	214	A6-604PL.084.30/DIMM 2-3	214
A5-692.40	122	A6-604P.084.30/DIMM 2-3	214	A6-604PL.084.30/EM	214
A5-692.40/DIMM 2-3	122	A6-604P.084.30/EM	214	A6-604PL.084.40	214
A5-692.40/EM	122	A6-604P.084.40	214	A6-604PL.084.40/DIMM 2-3	214
A5-693.70.30	122	A6-604P.084.40/DIMM 2-3	214	A6-604PL.084.40/EM	214
A5-693.70.30/DIMM 2-3	122	A6-604P.084.40/EM	214	A6-604PL.112.30	214
A5-693.70.30/EM	122	A6-604P.112.30	214	A6-604PL.112.30/DIMM 2-3	214
A5-693.70.40	122	A6-604P.112.30/DIMM 2-3	214	A6-604PL.112.30/EM	214
A5-693.70.40/DIMM 2-3	122	A6-604P.112.30/EM	214	A6-604PL.112.40	214
A5-693.70.40/EM	122	A6-604P.112.40	214	A6-604PL.112.40/DIMM 2-3	214
		A6-604P.112.40/DIMM 2-3	214	A6-604PL.112.40/EM	214
A6		A6-604P.112.40/EM	214	A6-604PL.140.30	214
A6-011	236	A6-604P.140.30	214	A6-604PL.140.30/DIMM 2-3	214
A6-012	236	A6-604P.140.30/DIMM 2-3	214	A6-604PL.140.30/EM	214
A6-015/100	214, 215, 218, 219, 226, 227, 232, 233, 236, 237	A6-604P.140.30/EM	214	A6-604PL.140.40	214
A6-017	236	A6-604P.140.40	214	A6-604PL.140.40/DIMM 2-3	214

CODICE	P.	CODICE	P.	CODICE	P.
A6-604PL.140.40/EM	214	A6-604S.168.30/EM	215	A6-606.2.168.40	189
A6-604PL.168.30	214	A6-604S.168.40	215	A6-606.2.168.40/DIMM 2-3	189
A6-604PL.168.30/DIMM 2-3	214	A6-604S.168.40/DIMM 2-3	215	A6-606.2.168.40/EM	189
A6-604PL.168.30/EM	214	A6-604S.168.40/EM	215	A6-606.2.196.30	189
A6-604PL.168.40	214	A6-604S.196.30	215	A6-606.2.196.30/DIMM 2-3	189
A6-604PL.168.40/DIMM 2-3	214	A6-604S.196.30/DIMM 2-3	215	A6-606.2.196.30/EM	189
A6-604PL.168.40/EM	214	A6-604S.196.30/EM	215	A6-606.2.196.40	189
A6-604PL.196.30	214	A6-604S.196.40	215	A6-606.2.196.40/DIMM 2-3	189
A6-604PL.196.30/DIMM 2-3	214	A6-604S.196.40/DIMM 2-3	215	A6-606.2.196.40/EM	189
A6-604PL.196.30/EM	214	A6-604S.196.40/EM	215	A6-606.2.224.30	189
A6-604PL.196.40	214	A6-604S.224.30	215	A6-606.2.224.30/DIMM 2-3	189
A6-604PL.196.40/DIMM 2-3	214	A6-604S.224.30/DIMM 2-3	215	A6-606.2.224.30/EM	189
A6-604PL.196.40/EM	214	A6-604S.224.30/EM	215	A6-606.2.224.40	189
A6-604PL.224.30	214	A6-604S.224.40	215	A6-606.2.224.40/DIMM 2-3	189
A6-604PL.224.30/DIMM 2-3	214	A6-604S.224.40/DIMM 2-3	215	A6-606.2.224.40/EM	189
A6-604PL.224.30/EM	214	A6-604S.252.30	215	A6-606.2.252.30	189
A6-604PL.224.40	214	A6-604S.252.30/DIMM 2-3	215	A6-606.2.252.30/DIMM 2-3	189
A6-604PL.224.40/DIMM 2-3	214	A6-604S.252.30/EM	215	A6-606.2.252.40	189
A6-604PL.252.30	214	A6-604S.252.40	215	A6-606.2.252.40/DIMM 2-3	189
A6-604PL.252.30/DIMM 2-3	214	A6-604S.252.40/DIMM 2-3	215	A6-606.2.252.40/EM	189
A6-604PL.252.30/EM	214	A6-604S.280.30	215	A6-606.2.280.30	189
A6-604PL.252.40	214	A6-604S.280.30/DIMM 2-3	215	A6-606.2.280.30/DIMM 2-3	189
A6-604PL.252.40/DIMM 2-3	214	A6-604S.280.30/EM	215	A6-606.2.280.30/EM	189
A6-604PL.280.30	214	A6-604S.280.40	215	A6-606.2.280.40	189
A6-604PL.280.30/DIMM 2-3	214	A6-604S.280.40/DIMM 2-3	215	A6-606.2.280.40/DIMM 2-3	189
A6-604PL.280.30/EM	214	A6-604S.280.40/EM	215	A6-606.2.280.40/EM	189
A6-604PL.280.40	214	A6-606.2.084.30	189	A6-607.2.084.30	188
A6-604PL.280.40/DIMM 2-3	214	A6-606.2.084.30/DIMM 2-3	189	A6-607.2.084.30/EM	188
A6-604PL.280.40/EM	214	A6-606.2.084.30/EM	189	A6-607.2.084.40	188
A6-604S.084.30	215	A6-606.2.084.40	189	A6-607.2.084.40/DIMM 2-3	188
A6-604S.084.30/EM	215	A6-606.2.084.40/DIMM 2-3	189	A6-607.2.084.40/EM	188
A6-604S.084.40	215	A6-606.2.112.30	189	A6-607.2.112.30	188
A6-604S.084.40/EM	215	A6-606.2.112.30/DIMM 2-3	189	A6-607.2.112.30/DIMM 2-3	188
A6-604S.112.30	215	A6-606.2.112.30/EM	189	A6-607.2.112.40	188
A6-604S.112.30/DIMM 2-3	215	A6-606.2.112.40	189	A6-607.2.112.40/DIMM 2-3	188
A6-604S.112.30/EM	215	A6-606.2.112.40/DIMM 2-3	189	A6-607.2.112.40/EM	188
A6-604S.112.40	215	A6-606.2.112.40/EM	189	A6-607.2.140.30	188
A6-604S.112.40/DIMM 2-3	215	A6-606.2.140.30	189	A6-607.2.140.30/DIMM 2-3	188
A6-604S.112.40/EM	215	A6-606.2.140.30/DIMM 2-3	189	A6-607.2.140.30/EM	188
A6-604S.140.30	215	A6-606.2.140.30/EM	189	A6-607.2.140.40	188
A6-604S.140.30/DIMM 2-3	215	A6-606.2.140.40	189	A6-607.2.140.40/DIMM 2-3	188
A6-604S.140.30/EM	215	A6-606.2.140.40/DIMM 2-3	189	A6-607.2.140.40/EM	188
A6-604S.140.40	215	A6-606.2.140.40/EM	189	A6-607.2.168.30	188
A6-604S.140.40/DIMM 2-3	215	A6-606.2.168.30	189	A6-607.2.168.30/DIMM 2-3	188
A6-604S.140.40/EM	215	A6-606.2.168.30/DIMM 2-3	189	A6-607.2.168.30/EM	188
A6-604S.168.30	215	A6-606.2.168.30/EM	189	A6-607.2.168.40	188
A6-604S.168.30/DIMM 2-3	215				

INDICE / INDEX

CODICE	P.
A9-651.30	19
A9-652.30	23
A9-654.30	25
A9-660.30	17
ESAL100A	276
ESAL100F	276
ESAL100L	276
ESAL200A	276
ESAL200F	276
ESAL200L	276
K	210, 236, 244
LE001-30/100	46, 47, 78, 188, 189, 192, 200, 210, 211
STR50012120.30	277
STR50012120.40	277
STR50025280.30	277
STR50025280.40	277
T	210
T002	169
T008	169
T013	169
TT	210
W	210, 236, 244
X	210, 236, 244
Y	210, 236, 244
Z	210, 236, 244

Headquarter

Via delle Industrie 14
20874 Busnago (MB) Italy
Tel. +39 039 6095574
Fax. +39 039 6095576

Ufficio Vendite Italia

Tel. +39 039 6095574
venditeitalia@aqlus.it

Export Sales Dept.

Tel. +39 039 6095575
export@aqlus.it

Reparto Tecnico

tecnico@aqlus.it

Aqlus

a brand of Biffi Luce S.R.L.

www.aqlus.com
aqlus@aqlus.it